



Apator SA, ul. Gdańska 4a lok. C4, 87-100 Toruń, Poland
e-mail: apator@apator.com, www.apator.com

Sales:

Apator Powogaz SA, ul. K. Janickiego 23/25, 60-542 Poznań, Poland
e-mail: handel.powogaz@apator.com
tel. +48 61 8418 133, 136, 138, 148

Compact Heat Meter

ELF

Technical description

For firmware versions 13.01 or higher

ISO 9001

PN-N-18001

ISO 14001



Contents

1. Subject 4

2. Regulatory and standard compliance 4

3. Design, functional description & basic characteristics 4

4. Basic specifications 5

5. Data types 8

5.1. Actual data 8

5.1.1. Heat consumption 8

5.1.2. Water volume 8

5.1.3. Supply and return temperatures; differential temperature 9

5.1.4. Power and flow 9

5.1.5. Pulse inputs 9

5.1.6. Error codes 9

5.1.7. Real and working time 10

5.2. Calibration, configuration and service data 11

5.2.1. Metrology-specific calibration and configuration data 11

5.2.2. User configuration data 11

5.3. Archive data 12

5.3.1. Record for cycle 1 (hourly) and cycle 2 (daily) 12

5.3.2. Monthly and annual cycle record 13

5.3.3. Emergency (failure) state archive record 13

6. Heat meter operating guide. LCD 14

6.1. Metrological test 16

7. Remote reading of data 16

7.1. Wired M-Bus interfaces and pulse I/O interfaces 17

7.1.1. Interface connection diagram 18

7.1.2. Interface technical parameters 19

7.1.3. Operating principle of the M-Bus communication interface 20

7.1.4. Pulse output configuration 20

7.2. Wireless interface 21

7.3. USB interface 22

8. Shipping and mounting 22

8.1. Sealing 23

8.2. Electrical interference 23

9. Warranty and service 24

9.1. Recommendations for end of life 25

10. Marking and ordering guideline 26

10.1. Ordering the complete heat meter assembly 26

10.2. Ordering the communication modules 27

11. Annexes 28

1. SUBJECT

This description is intended to present the characteristics, parameters and operation of Elf compact heat meters manufactured by Apator-Powogaz. The heat meters are intended to meter the heat consumption taken from heat distribution networks by small loads (e.g. apartments) with the heat power rating of 0.3 kW to 850 kW with Building Code compliant treated water as the heating medium. The heat meters are manufactured in five sizes for four nominal volume flow sizes. The sizes differ in diameter and connection types. The heat meter consists of a flow transducer, a pair of Pt 500 temperature sensors with wells and an electronic indicator resolver. All components form an integrated set for the user, i.e. the complete heat meter. The installed sensors are type TOPE42 Pt 500 temperature sensors and butterfly flowmeters without magnetic coupling which must be operated with only one specific type of electronic resolver.

Elf heat meters are compatible with remote reading interfaces and with up to four additional devices (e.g. a water meter or a gas meter) equipped with pulsers. The interfaces available are: one Wireless M-Bus, one M-Bus interface which enables connecting 2 additional pulsers and features a pulse output, an M-Bus for connecting 4 additional pulsers, and one M-Bus with 4 additional pulser inputs or 3 pulser inputs and one pulse output.

2. REGULATORY AND STANDARD COMPLIANCE

- Directive 2004/22/EC of the European Parliament and of the Council dated 31 March 2004 on measuring instruments, with specific consideration to Annex MI-004, Heat Meters.
- PN-EN-1434 – Heat meters, 6 parts.
- PN-EN 61000 – Electromagnetic compatibility (EMC). Parts 2-4.
- PN-EN 13757 – Communication systems for meters and remote reading of meters. Parts 1-4

3. DESIGN, FUNCTIONAL DESCRIPTION & BASIC CHARACTERISTICS

Elf compact heat meters consist of an electronic resolver with a pair of Pt 500 sensors permanently integrated with a butterfly flowmeter. The electronic system is located in a small tamper-proof enclosure which prevents access to electronic components and sensors after factory assembly. The base of the electronic system enclosure is connected to the flowmeter body with a band clip locked with a wire seal. The enclosure base is fastened to the rest of the enclosure with two screws; the enclosure is sealed by applying a self adhesive seal made of a special brittle sheet at the enclosure separation line, and on the fastening screw head opening. The electronic circuit features special pins for a jumper. The removal of the jumper disables access to calibration and configuration of metrological parameters of the heat meter. The part of the setup parameters which do not affect the measurement accuracy is adjustable by the user, i.e. the administrator or the technical service.

The flowmeter rotor features a disk made of an EM-immune metal. The rotor revolutions are measured by the electronic system with induction coils; only connecting the flowmeter to the electronic circuit makes the flow transducer complete; addition of the temperature sensor pair completes the compact flowmeter. The modern revolution detection method combines excellent metrological performance with resistance to strong magnetic fields. The flow transducer system resolution enables detection of as little as $\frac{1}{4}$ of rotor revolution; moreover, the implemented electronic calibration results in a very smooth error chart within the entire range of flow variations.

The temperature sensors are permanently soldered to the resolver PCB. The temperature is measured in 16-second intervals in the basic operating mode when flow is present. If there is no flow present, the temperature is measured twice in the averaging period (cycle 1 duration). The heat gain is calculated and added to the total consumption register at an interval of at least 8 seconds only if volume gain occurs in the given period.

The calculation formula is:

$$Q = \int_{V1}^{V2} k(t1 - t2)dV$$

Q - quantity of consumed heat

dV - volume of flowing water

k - temperature coefficient of water

t1 - supply water temperature

t2 - return water temperature

Another value, which is called the resolver metrological test, is calculated to evaluate the metrological class of the electronic system as a stand-alone resolver for the heat meter. The calculations of instantaneous water volume flow and instantaneous power are performed in the heat gain calculation period of 8 seconds. If not even ¼ of revolution is detected over that period, the instantaneous values will be reset to zero; the situation corresponds to actual flows which are at least twice times lower than the minimum values listed in the technical data.

The electronic resolver allows the user to set the parameter called the averaging period. The period (15 to 1440 minutes) is used to calculate the average values of flow, power and temperatures, as well as to save the states of consumption registers, including the heat register, from the CPU RAM module to non-volatile flash memory. Each time a heat consumption gain is added to the main register, a special checksum is calculated; if an operating disturbance occurs, i.e. when the checksum is changed with an error (e.g. when replacing the battery), the consumption data is loaded from nonvolatile memory to RAM. If it is not possible to load the consumption data or the configuration data, operation is no longer possible, which is indicated by a suitable message.

The resolver determines the maximum and minimum values of flow, power and temperatures from the values calculated in the averaging period. It is possible to record the states of consumption logs and the maximum and minimum values in different time cycles. 1 to 4 cycles can be configured, with the data writing periods of the cycles and the number of recordings for each cycle. The heat meter also records failure conditions, e.g. failure of temperature sensors. The electronic circuit is powered with a lithium battery or two lithium batteries (size AA) which guarantee uninterrupted operation for a minimum of 5 or 10 years, respectively, in normal operating conditions. All interfaces this heat meter is compatible with are located in a separate enclosure which can be removed from this product without breaking the seal of the main enclosure. Even if empty, the interface enclosure must be properly attached to maintain the hermetic seal. The heat meter measures the battery voltage under load and if voltage drops below the permissible value (3 V), the heat meter issues the applicable error code; when voltage drops below 2.7 V, the heat meter operation is locked out.

The heat meter can work in three modes:

- the calibration mode – with the jumper installed; changing the calibration parameters or metrological configuration of the heat meter is available only in this mode;
- the test mode – the electronic system operates at a higher power consumption and generates special signals to test the metrological class of the flow transducer;
- the user basic operating mode – with a minimum battery power consumption.

4. BASIC SPECIFICATIONS

The basic specifications are listed in the table below; the maximum error values are listed for both complete heat meter unit and specific measurement components.

In accordance with PN-EN-1434-1:2009, the MPE of the integrated heat meter is the arithmetic sum of errors of all components: $E_c = \pm(3 + 0,02 * q_p/q + 4 * \Delta\Theta_{min}/\Delta\Theta)$.

Flow transducer							
Manufacturer mark		-	APATOR POWOGAZ S.A.				
Factory mark		-	JS90-0,6 -NI	JS90-1 -NI	JS90-1,5 -NI	JS90-1,5 -G1-NI	JS90-2,5 -NI
Nominal diameter	DN	-	15	15	15	20	20
Minimum volume flow - horizontal arrangement H	q _i	dm ³ /h	6	10	15	15	25
Minimum volume flow - vertical arrangement V	q _i	dm ³ /h	12	20	30	30	50
Nominal volume flow	q _p	m ³ /h	0,6	1,0	1,5	1,5	2,5
Maximum volume flow	q _s	m ³ /h	1,2	2,0	3,0	3,0	5
Starting threshold	q _r	dm ³ /h	2,5	2,5	4,5	4,5	7,5
Measurement range q _r /q _i - horizontal arrangement H		-	100				
Measurement range q _r /q _i - vertical arrangement V		-	50				
Limit MPE - horizontal arrangement H	E _r	%	E _r = ±(2 + 0,02 q _r /q _i)				
Counter reading range		m ³	10 ⁴				
Scale interval value		dm ³	1				
Maximum permissible operating pressure	acc. to PN-EN 1434- 1:2009	bar	PS16				
		bar	MAP16				
Nominal pressure	1:2009	bar	PN16				
Maximum pressure loss at q _p		bar	ΔP25				
Temperature range limits		°C	Θ _{min} = 0,1°C to Θ _{max} = 90°C				
Flow disturbance resistance class acc. to EN 14154-3:2005		-	U0, D0				
Installation arrangement		-	H, V				
Signal processing constant		imp/dm ³	90	50	40	40	32
Backflow		-	no				
Accuracy class 2 acc. to PN- EN-1434-1:2009, arrangement H (V)		-	Class 2 (3)				
Water meter thread diameter	G		G 3/4	G 3/4	G 3/4	G1	G1
Water meter length	L	mm	110	110	110	130	130
Relative humidity		%	≤ 100				
Environment Class A	Climate		operation in closed (indoor) areas Operating temperature range: 5 to 90°C - low humidity - normal electrical and EM exposure levels - low mechanical exposure level				
	Mechanical		Class M1				
	Electromagnetic		Class E1				

Electronic resolver			
Manufacturer mark	–	APATOR POWOGAZ S.A.	
Energy unit, selectable	–	GJ, kWh or Gcal	
Display type	–	LCD, 7 digits, height: 7 mm	
Type of resolver fastening to water end	–	Rotary – revolution angle 0 to 360°	
Transducer electronic circuit	–	Integrated with the resolver electronic circuit	
Readings cycling	–	One button	
Auxiliary modules	–	Communication modules: M-Bus, Wireless M-Bus, USB, modules with 4 pulse inputs max. and 1 pulse output	
Temperature range limits	wg PN-EN 1434-1:2009	°C $\Theta_{\min} = 1\text{ °C} \quad \Theta_{\max} = 105\text{ °C}$	
Differential temperature range limits		°C $\Delta\Theta_{\min} = 3\text{ °C} \quad \Delta\Theta_{\max} = 104\text{ °C}$	
Limit MPE	%	$E_c = \pm(0,5 + \Delta\Theta_{\min} / \Delta\Theta)$	
Temperature sensors	–	PT 500	
Power supply	–	Lithium battery, 3,6 V; 2,1 Ah minimum, size AA, $U_{\min} = 3V$	
Battery life	lat	5+1 or 10+1 (depending on heat meter version)	
Protection class, IEC-529	IP	–	IP54
Ambient temperature	t_a	°C	5 to 55
Relative humidity	W	%	< 90
Overall dimensions	mm		70 x 75 x 80
Weight	kg		0,35
Serial baud rate, selectable	Baud		300, 600, 1200, 2400, 4800, 9600
Stop bits	–		1
Data bits	–		8
Parity	–		Even, Odd, None
Mean current consumption in the operating/ test operating mode	μA		~25/~100

Resolution of available data	LCD	M-Bus	Archives
Energy	0,001 GJ/ 0,1 kWh/ 0,001 Gcal	0,1 kJ/ 0,01 Wh/ 0,1 kcal	0,1 kJ/ 0,01 Wh/ 0,1 kcal
Volume	0,001 m ³	0,001 m ³	0,001 m ³
Additional inputs	0,001 .. 1 m ³ / 0,001 .. 1 kWh	0,001 .. 1 m ³ / 0,001 .. 1 kWh	0,001 m ³ / 0,001 kWh
Instantaneous temperature	0,01 °C	0,01 °C	–
Instantaneous flow	0,001 m ³ /h	0,001 m ³ /h	–
Instantaneous power	0,1 kW	0,1 kW	–
Average, maximum and minimum temperature	–	–	0,01 °C
Average, maximum and minimum flow	–	–	0,001 m ³ /h
Average, maximum and minimum power	–	–	0,1 kW
Operating time	1h	1h	1h

Temperature sensor pair		
Manufacturer mark	–	APATOR POWOGAZ S.A.
Thermometer resistor	–	Pt 500 (TOPE42)
Method of connection with the resolver	–	soldered
Temperature measurement range	°C	$\Theta_{\min} = 0 \text{ }^{\circ}\text{C}$ $\Theta_{\max} = 105 \text{ }^{\circ}\text{C}$
Differential temperature range	°C	$\Theta_{\min} = 3 \text{ }^{\circ}\text{C}$ $\Theta_{\max} = 104 \text{ }^{\circ}\text{C}$
Maximum operating pressure	MPa	1,6
Maximum measurement current	mA	5
Sensor well material	–	steel, 1H18N9
Outer well material	–	No outer well
Limit MPE	E_1	% $E_1 = \pm(0,5 + 3 * \Delta\Theta_{\min} / \Delta\Theta)$
Connection cable	–	spiral, PU insulation, 2x0.25 mm ² , length: 2m
Overall dimensions	mm	70 x 75 x 80
Weight	kg	0,35

5. DATA TYPES

The measured and calculated data can be divided into two groups:

- actual data, which is determined in 8 second intervals (except for temperature values in the basic operating mode);
- averaging period data (period adjustable by the user), displayed in the service data group;
- archive data, in up to 4 user-configurable cycles;
- configuration (service) data, which can also be adjusted by the user if not metrology-specific;
- test data, displayed in the test mode.

The data reading methods are described in the section of the heat meter operating guide. The following presents the meaning and interpretation of measured values

5.1. Actual data

This is the data from the measurements and from the calculations made with the input of current measurements. The data is updated every 8 seconds (except for the temperature data which is updated every 16 seconds and only if the flow is present) and displayed as basic data; the exception is the real time clock and the metrological test which are service data, despite the same update interval.

5.1.1. Heat consumption

Heat consumption is calculated as shown in Section 3, in one of three selectable energy units, e.g. GJ, kWh or Gcal (the unit symbol is not displayed). The user must select the unit upon ordering, since it is not possible to change it once the heat meter has been sealed. The heat consumption register is 11 decimal digits long, with the least important four digits displayed in the test data group.

5.1.2. Water volume

Water volume is calculated by totalling very small volume doses per one revolution of the flow transducer rotor. The revolution measurement resolution is $\frac{1}{4}$ of revolution, yet this resolution is only used in the sense of rotation detection. Volume is summed only if a full revolution in the proper sense of rotation is detected. The revolution value in millilitres varies with the instantaneous rotational speed which in turn is determined by measuring the time interval between two successive revolutions. The calibration of the flow transducer consists in experimental determination of the revolution value at

characteristic points of the error curve of the flow transducer, followed by recording the value in the electronic circuit memory module. This results in a smooth error chart over the entire flow range for each transducer. The revolution value is not changed at actual flows which are above the maximum value or below approx. one half of the minimum value; in this case calibration is inactive. The volume is displayed as a value of seven digits with the accuracy of 1 dm³ (litre). In order to perform quick metrological tests, the heat meter can be switched to the test operating mode and enable the fast pulse output according to the technical data table. An additional register of simulated volume is also enabled in the test operating mode – see the test mode description.

5.1.3. Supply and return temperatures; differential temperature

The temperature values are determined by measuring the Pt500 sensor resistance. The RAM register stores the supply and return temperature values of the medium with the calculated differential temperature value. Each temperature value is determined down to 0.001 °C, displayed with the accuracy of 0.01 °C and transmitted to remote reading devices with the accuracy of 0.1 °C of transmitted data.

If a failure or overflow of one of the temperature sensors occurs, the failure is signalled by issuing an applicable error code and by displaying a flashing q symbol and the corresponding value in the given temperature menu. If the sensor inputs are shorted or the temperature is below range, the value of 0.00 °C is displayed. If the circuit is broken or the temperature is above range, the value of 999.99 °C is displayed. The same values are displayed for the temperature means determined during a temperature measurement error. In both cases the displayed differential temperature is 999.99 °C, which is also indicated with the flashing error symbol. The value transmitted to remote reading devices is labelled as a value during error and it is displayed as 999.9 °C or 000.0 °C.

5.1.4. Power and flow

Instantaneous flow is determined by measuring the duration of one full revolution of the flow transducer rotor. The flow calculation accuracy error is below 4%. If as low as ¼ of revolution is not detected in 8 seconds, the flow indication is reset to zero. In practical terms, it is a flow value which is approximately one half of the minimum flow value, yet it is higher than the starting threshold for the given flow transducer type. Instantaneous power is determined as the product of instantaneous flow and metrological test (see section 6.1.).

5.1.5. Pulse inputs

The heat meter can be connected to a maximum of four additional devices equipped with pulsers. The user may configure the inputs as volumeters (water meters) or power meters. It is possible to deactivate each input by setting the pulse constant to zero. If an input is deactivated, the meter status for that input is omitted on the display and not transmitted in M-Bus frames. Only low frequency signals are used; however, it is possible to order custom interfaces of any type which will convert the signals to compatible pulses. Only the interfaces from Apator-Powogaz shall be used, since they ensure proper interference protection of pulse inputs.

5.1.6. Error codes

This register is not displayed during correct operation (error code = 0); an error will be indicated by the flashing symbol  with the error code displayed in the basic data menu. The failure states of the measurement system are indicated with the error codes meaning as follows:

- 1 – exceedance of minimum flow, error raised when average minute flow is other than zero and lower than the minimum flow;
- 2 – no pulse from water metre and $\Delta T > 10^{\circ}\text{C}$ in 24 hours (the user can modify both parameters: no pulse period and temperature difference);
- 4 – return temperature sensor damaged or temperature outside of range;

- 8 – supply temperature sensor damaged or temperature outside of range;
- 16 – temperature sensors interchanged or negative differential temperature; indicated if $|\Delta T| > 0.3^{\circ}\text{C}$, the error is saved to archive data if $|\Delta T| >$ differential temperature insensibility value;
- 32 – exceedance of maximum flow $Q_s = 2 * Q_p$ computed as mean for one minute;
- 64 – error when writing to flash memory – flash failure;
- 128 – battery voltage below minimum value (3.0 V – writing of archive data to non-volatile memory is disabled; replace the battery in 60 days or following the heating season);
- 256 – non-standard exceedance of rated flow ($Q_p < Q \leq Q_s$) during 1 hour per every 24 hours; every 24 hours counted from the first occurrence of exceedance. If during the immediate 24 hours from the exceedance's detection the time of exceedance is greater than 1 hour, an error will be raised. The error is deleted after 24 hours from the detection of exceedance;
- 512 – non-standard exceedance of rated flow ($Q_p < Q \leq Q_s$) during 200 hours per year; a year is counted from one settlement period to the following settlement period (the moment of recording annual data); if within this period the flow is exceeded by at least 200 h, an error will be raised until the end of the settlement period,
- 1024 - Temperature differential too low: This error is indicated when the mean temperature differential during cycle 1 is below the preset energy totalling threshold; default setting: 2.7°C (customizable on order).
- 2048 - Periodic comparison of the firmware memory CRC to the stored pattern; this error is indicated if the comparison outputs a mismatch.

Error codes can be added up, e.g. "Er 12" means that both sensors are damaged. Errors are automatically deleted once their cause(s) have been removed. Even one instance of an error is recorded in the archive data. The incorrect operation time meter is incremented only if the error persists for a whole hour. There is a special archive of emergency operation (failure) states described further in the user manual. When an error consisting in damage of contents of heat consumption register is raised, correct data are read into the registers from nonvolatile memory. If loading of data is impossible due to a nonvolatile memory failure or when the battery power is too low (below 2.8V), a proper message is displayed and the heat meter stops metering.

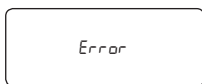

flash memory corrupt

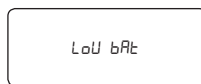

battery voltage too low

When errors 2, 4, 8, 16 and 1024 occur, no energy is calculated.

5.1.7. Real time and working time

The data of the real time clock is updated each second, yet its display is in the service data group. The user can modify the data. The calendar automatically switches to Polish daylight saving time and back. Automatic switching to and from the daylight saving time can also be disabled. The RTC is based on a standard 32768 Hz quartz crystal the accuracy of which depends on the ambient temperature. Since the heat meter is operated at varying temperatures of as much as 90 °C, the clock readings can have a significant error of as much as several minutes per month.

The operating time and the error operating time are counted in hours. The error operating time count increases only if an error persists for a whole hour.

Working time:

The heat meter has been provided with two registers for calculation of working time. Working time is calculated in minutes but it is displayed in hours:

- non-standard working time – time calculated in case of errors: 2, 4, 8, 16, 32 1024,
- standard working time – time calculated in all other cases; no error is raised or errors: 1, 64, 128, 256 or 512 are raised.

5.2. Calibration, configuration and service data

The data is divided into two categories: the data which affects the heat meter measurement accuracy and the data for configuration of operating functions. The most critical parameters can be read from the LCD (see the operating guide); the rest is accessed only via serial communication (see the description of the heat meter communication).

5.2.1. Metrology-specific calibration and configuration data

During the manufacturing stage, i.e. prior to closing the enclosure and applying the self-adhesive seals, the metrological parameters of the heat meter are calibrated and configured. A partition of the flash memory is dedicated to this data group as isolated from other stored information and the programming is carried out with the use of the production line stand software. When the production of a meter is complete, the user of the meter cannot access that data.

5.2.2. User configuration data

This data can be configured by the user with the use of the ElfSerwis service software.

The following is a list of this data with their meaning (factory default settings are shown in brackets):

- cycle 1 registration time (15-1440 minutes – factory setting: 60), it is also a period for calculation of means for cycle 1 and maximum and minimum values for monthly and annual registration,
- the period of average calculation, which is also the cycle 1 recording period (15 to 1440 minutes, default: 60), of the values of flow, power and temperatures, and for saving the consumption register states (including the heat consumption register) from the CPU RAM to the non-volatile flash memory; the maximum and minimum values are determined with the input of the average values;
- the cycle 2 recording period (60 to 1440 minutes, the default is maximum, i.e. 1440 minutes = 1 day/24 hrs);
- the minimum differential temperature value for determination of Error 2 (10 °C) – see the description of error codes;
- the time to determine Error 2 (24 h), counted in full hours – see the description of error codes;
- the customer/user number, an eight-digit identification number (configured by the user) – the default is the heat meter serial number; used for M-Bus secondary addressing;
- the pulse constants of additional pulse inputs (0 dm³/pulse – input inactive); available units: dm³/pulse or pulse/kWh; only pulsers rated at below 0.5 Hz are supported, higher frequencies require ordering customised interfaces;
- the data recording archive configuration (see the description of archive data) 1 to 4 time cycles can be selected during which data will be recorded; it is possible to selected the number of required registrations for each cycle, which is only limited by the flash memory partition dedicated to the archive;
- the serial transmission parameters (2400 bauds, parity: even);
- the M-BUS network address number (01);
- hour of recording of monthly and annual data (01:00);
- day of recording of monthly and annual data (1);
- month of recording of annual data (July);
- the pulse output mode configuration, available options:
 - fast test output, pulse/rev;
 - fast output, pulse/l, with the constant dependent on the flow sensor body;
 - the pulse value equal to 1, 0.1, or 10 times the lowest heat unit shown on the LCD;
 - output disabled.

5.3. Archive data

Archiving of the heat meter data is fully configurable by the user with the ElfSerwis configuration software (see the detailed description in the separate document). A space intended for archived data can be divided in any way between 4 types of archives, archive for cycle 1, archive for cycle 2, monthly archive and annual archive. The user configures the number of registrations for a given archive. If zero is set, it means that a given registration cycle is inactive. The recording period of cycle 1 and 2 is set by the user in minutes, from 15/60 to 1440 (24h). Monthly data are recorded at an hour and on a day set by the user. Similarly, annual data are recorded at an hour and on a day of recording of monthly data, in a month set by the user.

If the entire space for one type of archive is used, it can be recorded as follows: for archive for cycle 1 / cycle 2 - up to 1667 registrations, for monthly archive - up to 241 registrations, whereas for annual archive - up to 20 registrations. The following configuration of archive space arrangement is factory-set:

- cycle 1 (hourly) - 747 registrations,
- cycle 2 (daily) - 80 registrations,
- cycle 3 (monthly) - 20 registrations,
- cycle (annual) - 10 registrations.

Note: A change of the number of registrations for any archive brings about the deletion of the entire memory area meant for registration and the loss of the archived data. If at the moment of recording the registrations for group 2 or 3 are displayed, they will cease to be displayed and LCD will return to group 1 for basic data.

The following sections of the description provide structures of registered records. Every record consists of an identifier, data and recording time for the record and the values for basic heat meter registers. For individual periods of recording into archive mean values are also determined (temperature, power and flow), whereas:

- mean values for cycle 1 and cycle 2 data are determined on the basis of instantaneous values,
- mean values for monthly cycle data are determined on the basis of mean values from cycle 1, whereas for annual cycle on the basis of mean values from cycle 2.

Moreover, monthly and annual records include maximum and minimum values (of temperature, power and flow) along with dates and times of their occurrence. Peak values are determined on the basis of mean values from cycle 1.

5.3.1. Cycle 1 record (hourly) and cycle 2 (daily)

Data type	Size in bytes
Record number – AMR	4
Recording time and date	5
Heat	6
Volume	4
Standard working time	4
Non-standard working time	4
Additional pulse input 1	10
Additional pulse input 2	10
Additional pulse input 3	10
Additional pulse input 4	10

Data type	Size in bytes
Average power per cycle duration	2
Average flow per cycle duration	2
Average supply temperature per cycle duration	2
Average return temperature per cycle duration	2
CRC for the data	1
Total	74

5.3.2. Monthly and annual cycle record

Data type	Size in bytes
Record number – AMR	4
Recording time and data	5
Heat	6
Volume	4
Standard working time	4
Non-standard working time	4
Additional pulse input 1	10
Additional pulse input 2	10
Additional pulse input 3	10
Additional pulse input 4	10
Average power for cycle period	2
Average flow for cycle period	2
Average feed temperature for cycle period	2
Average return temperature for cycle period	2
Maximum power per cycle	2
Minimum power per cycle	2
Maximum flow per cycle	2
Minimum flow per cycle	2
Maximum flow temperature per cycle	2
Minimum flow temperature per cycle	2
Maximum return temperature per cycle	2
Minimum return temperature per cycle	2
Date and time when these extreme values occur	32
Error code	2
CRC for the data	1
Total	126

5.3.3. Emergency (failure) state archive record

Furthermore, Elf heat meters are provided with archive for emergency states. A space intended for this archive is permanent and its volume cannot be configured, as opposed to periodic archives.

Data type	Size in bytes
Record number – AMR	4

Data type	Size in bytes
Recording time and data	5
Heat	6
Volume	4
Standard working time	4
Non-standard working time	4
Additional pulse input 1	10
Additional pulse input 2	10
Additional pulse input 3	10
Additional pulse input 4	10
Error code after failure detection	2
Error code before failure detection	2
CRC for the data	1
Total	72

6. HEAT METER OPERATING GUIDE. LCD

The heat meter is operated with a single push-button and an LCD. The push-button has two functions: short depress cycles between the successive screens of one menu group; long depress enters or exits a menu group. If the readings need to be displayed or configured remotely, use the software, interfaces and other tools from Apator-Powogaz and follow the manuals enclosed with these products.

The display of data on Elf heat meters is divided into five menu groups which correspond to the functionality of the data:

- actual data – group 1
- monthly recording data – group 2
- annual recording data – group 3
- service data – group 4
- test data – group 5

The data from recording in cycle 1 and 2 and from failure recording can only be read via the communication interface.

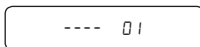

Press the button repeatedly until the desired group number is displayed with messages.

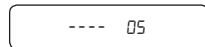
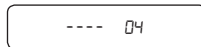
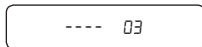
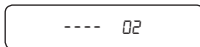

You can switch between the display groups as follows: hold the push-button for approx. 2 seconds until the group number is displayed. Release the button.

Then press and hold again until the first value of the selected group is displayed.

The successive values in group 1, 4 and 5 (actual, service, test) are displayed by repeatedly pressing the button.

When switched to display the data in group 2 and 3 (registered data), the displayed values cycle every 2 seconds. The first reading is the message with the number of maximum registrations available in the group. This message is displayed only once per each access to the data group (it does not repeat in cycling).



The displayed number depends on the user configuration. If "0" is configured for the given group, the group is disabled from recording.

This reading is followed by a cycled display of successive values in the record; at the beginning of each record shows a message which record will be displayed at the given moment and how many records have been registered, e.g.



the 10th registration (the latest) out of 10 is displayed.

Short press of the push-button displays the next written record - see the screen image below:

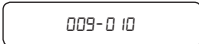

the 9th registration (the second latest) out of 10.

If the record is corrupted, (the CRC of the data in the record is incorrect), the record number will be displayed alternately with the error message. Example (see below): the messages will be displayed alternately to alert that the data is incorrect.

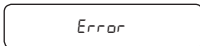
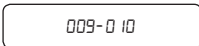

If the next registration increases the number of registrations above the maximum (set by the user), the 4 oldest registrations will be deleted and the new one written. Hence the displayed number of registrations will decrease by 3 and increase by 1 after the next write, etc. If the next registration occurs when the archive is viewed, the registration data display will be stopped and restarted by showing the number of maximum registrations for the specific archive group. If during the display of data in group 2 or 3 a configuration write of registration cycles is made, the display will be stopped and the LCD will revert to group 1 of basic data.

If the symbol Δ flashes when displaying the actual data, an error has occurred and the error code is not zero.

If \rightarrow is displayed, there is flow in the direction of counting volume and heat.

The symbol \leftarrow means that the current flow direction is wrong. When very small flows occur, the direction symbols will appear shortly.

The symbol ∇ means that the jumper is installed and writing of calibration and configuration data is possible.

The LCD returns to the actual data display and shows the heat consumption in any operating mode if the push-button is not operated for ca. 3 minutes.

The annexes feature figures which provide guidance on operating the LCD.

Annex A shows the display in the basic operating mode of the heat meter with the recording configured to disable monthly and annual registrations.

Annex B shows the display of monthly and annual registrations provided that they are active and correct.

If the heat meter is unable to correctly read the configuration or consumption data following battery replacement, its operation is halted and the following message is displayed:

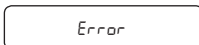

The user can only call the technical service.

6.1. Metrological test

The value "test" is the heat quantity [kJ] per 1 m³ of water at the given differential temperature. It is used to verify that the resolver works correctly. In order to test the meter, call the indication "test" at the given differential temperature, calculate the heat energy per 1m³ of water and then compare the result to the indication.

Use the heat measurement principle:

$$Q = V * k * (t_1 - t_2) \quad \text{where: } Q - \text{heat}$$

V - volume of medium
k - temperature coefficient of water
t₁ - supply temperature
t₂ - return temperature

The reference heat value per 1 m³ of the medium is: $Q = 1 * k * (t_1 - t_2)$

Example:

Input data: t₁ = 70 °C, t₂ = 50 °C

The temperature coefficient for the heat meter supply side, calculated acc. to EN-1434-1:2009

Annex A: k = 4.09105 [MJ /m³ K].

Reference heat:

$$Q_w = 1 * 4.09105 * (70 - 50) = 81,821[\text{MJ}] = 81821 [\text{kJ}]$$

Assume that the tested meter shows QT = 82000 [kJ], then the resolver error is:

$$E_o = [(82000 - 81821) / 81821] * 100 \% = 0.22 \%$$

Compare the obtained error value E_o to the maximum permissible error values E_i from the technical data table. If at the given differential temperature E_o < E_i then the meter correctly calculates the heat energy quantity. The test procedure presented here can be carried out on a working heat energy metering system without stopping the heat meter or breaking the meter seals. The meter calculates the value "test" following each temperature measurement. The best method for evaluating the resolver error is to calculate the average of several (e.g. eight) successive readings of the resolver test, since a single measurement suffers from a certain statistical fluctuation of approx. ±0.5 % (at the minimum differential temperature).

7. REMOTE READING OF DATA

Elf heat meters feature a connector for communication interfaces which enable remote reading and writing of data. The connector also enables connection of pulse signals with additional pulse inputs, and to output the pulses generated by the heat meter to one of the output interfaces. Only interfaces from Apator-Powogaz shall be used, since they ensure proper support of the heat meter. The interfaces are installed on the heat meter without tampering with the heat meter verification markings, as shown in the following diagrams. Route the wiring for interface connections through proper penetrations to maintain the declared enclosure protection rating. It is recommended to have the interfaces installed by a competent service technician and sealed with the service sticker seal once installed and commissioned.

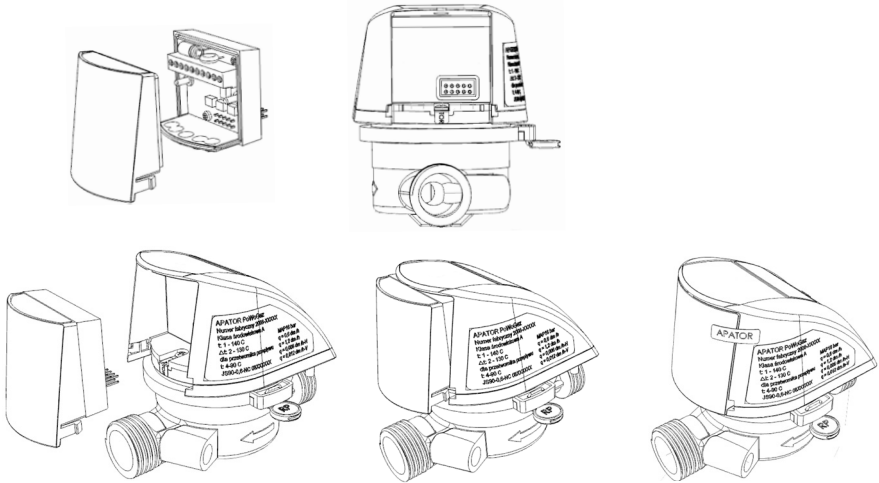

Wired M-Bus interfaces are available for connecting of up to four additional pulse inputs and with one pulse output, the pulse I/O interfaces with a maximum of four auxiliary pulse inputs and one pulse output, a Wireless M-Bus interface, and an USB interface.

Interface	M-Bus	Pulse OUT	Pulse IN
M-Bus + 4 pulse inputs	+	-	4
M-Bus + 2 pulse inputs + 1 pulse output	+	1	2
4 pulse inputs	-	-	4
3 pulse inputs + 1 pulse output	-	1	3
Wireless M-Bus	-	-	-
USB	-	-	-

7.1. Wired M-Bus interfaces and pulse I/O interfaces

Data reading with the M-Bus communication interface is based on the transmission protocol compliant with PN-EN 13757-3:2005 and PN-EN 1434-3:2009. The implemented protocol enables primary addressing with 1-byte network addresses, secondary addressing with the 8-digit customer identifier and extended secondary addressing with the serial number.

The following is the list of data read over M-Bus:

- heat meter serial number
- customer/user number
- current date
- heat consumption

- volume read from flow transducer
- readings of counters on four additional pulse inputs (as volume or energy in the additional tariff from 1 to 4 in succession) NOTE: the counter value is not transmitted if its input is deactivated
- instantaneous temperatures, flow and power
- error code
- standard and non-standard working time

It is possible to remotely read the data records registered as shown in section 5.3 of this description. The configuration data reading and saving is only possible with the ElfSerwis software. It is possible to remotely set the configuration parameters; however, some of them require installing the jumper which enables the service mode.

The following are the parameters changed with the jumper installed:

- full metrological configuration, selection of flow sensor type and its calibration;
- calibration of the resolver with the temperature sensors as the reference;
- selection of supply/return;
- selection of GJ/kWh/Gcal;
- setting the initial value (resetting) of the heat consumption meter;
- differential temperature insensibility.

The list of parameters which can be set remotely without the jumper:

- setting the initial values (resetting) of all pulse inputs, operating time, error operating time and volume counter;
- pulse constants for all auxiliary inputs;
- configuration of the number of registrations within archives;
- determination of period for registration of cycle 1 and 2 data;
- pulse output configuration;
- parameters of error 2 detection (no flow at high differential temperature);
- setting the unique customer/user number;
- network address and baud rate – requires respective changes in the user PC;
- selection of hours, days of month and months of year for recording.

Note on readout frequency and default transmission settings:

Transmission of data from Elf increases consumption of the battery power. If readout frequency is higher 15 minutes, the battery life may be shorter. This applies only for the default baud rate of 2400; if a lower baud rate is selected, the readout frequency is proportionally lower. The CPU flash memory stores the number of transmissions sent by the heat meter, so it is possible to check the data readout frequency following replacement of the dead battery. If the defined transmission number is exceeded in the design operating life of 5 years of the heat meter (which is approx. 880,000 bytes of U ART transmission for M-Bus readouts), the manufacturer shall not be liable for premature battery discharge and shutdown of the device. The transmission parameter defaults are: 2400,8,e,1; network number 1; customer number is the serial number.

7.1.1. Interface connection diagram

The following diagrams show the sequence of signals on the screw terminals of the interfaces in all available heat meter versions. The diagram shows the connection of dry contacts for the pulse inputs.

Version 1: M-BUS + 4 pulse IN

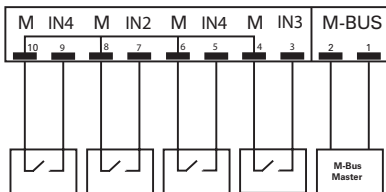

Version 2: M-BUS + 2 pulse IN + 1 pulse OUT

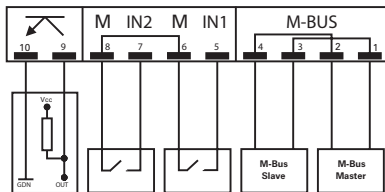

Version 3: 4 pulse IN

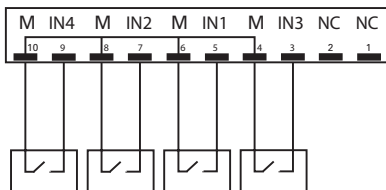

Version 4: 3 pulse IN + 1 pulse OUT

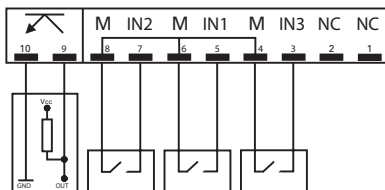

where:

IN1, IN2, IN3, IN4 are the pulse input terminals;

M are the pulse input terminals connected to the interface common;

M-BUS is the I/O for connection with the M-Bus line (any wiring connection sequence is allowed);

NPN transistor symbol is the pulse output;

NC is spare, i.e. not used in the given module version.

7.1.2. Interface technical parameters

The table below shows the technical parameters of individual interface blocks

Interface parameters		
Enclosure		Integrated with the heat meter main enclosure by 2 snap fasteners; electrical connection: 2x5 pin (2.54 mm matrix)
Operating temperature	°C	0 ÷ +55
Power supply		M-Bus interfaces are powered by the transmission lines
M-BUS - optional		
Maximum voltage	V	42
Maximum interface current consumption	mA	2
Wire insulation voltage rating	V	> 500
Maximum wire length in network	m	< 1000*
Maximum no. of interfaces in network		depending on the permissible converter load
Baud rate	Baud	300, 600, 1200, 2400, 4800, 9600
Maximum cross section of supply wires	mm ²	< 1,5
Recommended M-Bus cable		YnTKSY 1x2x1,0 mm
Maximum recommended readout frequency (at 2400 bauds)	s	900
Internal interface register refresh interval	s	60 (the register refresh interval is the time at which M-Bus polls the heat meter for the actual register status)

Pulse input (dry contact, NO, open collector, open drain)		
Maximum voltage	V	6
Maximum current	mA	0,05
Wire insulation voltage rating	V	> 500
Maximum wire length	m	10
Maximum no. of inputs	qty	4 (2)
Max frequency of input pulse	Hz	0,5
Input pulse duration	ms	625
Input pulse interval	ms	625
Maximum cross section of supply wires	mm ²	< 1,5
Reel relay make input impedance	kΩ	< 10
Reel relay break input impedance	MΩ	> 3
Pulse output (optical coupler) - optional		
Maximum voltage	V	24
Maximum current	mA	10
Voltage drop across optical coupler at I _{max}	V	1
Wire insulation voltage rating	V	> 500
Maximum wire length in network	m	10
Max frequency	Hz	64
Minimum pulse duration	ms	7,8
Minimum pulse interval	ms	7,8
Maximum cross section of supply wires	mm ²	< 1,5

*1 the length can be much shorter under high ambient interferences

7.1.3. Operating principle of the M-Bus communication interface

Once installed, the interface of the resolver requires no further configuration settings. Install the interfaces on the heat meter before supplying power to the M-Bus network; then the communication with connected heat meters is enabled.

The actual data transmitted over M-Bus are buffered in the interface. The actual data is read from the heat meter when the interface is installed on the device and the M-Bus network power is on, which in the operating mode is ~1 minute after the last poll. When the configuration is read/written, the communication is direct with the heat meter.

7.1.4. Pulse output configuration

You can configure six operating states of the pulse output:

- basic state: output inactive;
- pulse per revolution of the flow sensor rotor;
- test mote: the pulse value is directly proportional to the volume measured by the flow transducer and the pulse constant depends on the flow sensor;
- heat-proportional output – available settings (see the table below):
 - one pulse is a 0.1 increment of the lowest possible heat value displayed on the LCD;
 - one pulse is the increment by the lowest possible heat value displayed on the LCD;
 - one pulse is 10 times the lowest possible heat value displayed on the LCD.

Pulse output configuration	Heat unit		
	GJ	kWh	Gcal
0.1	0.1 MJ/pulse	0.01 kWh/pulse	0.1 Mcal/pulse
1	1 MJ/pulse	0.1 kWh/pulse	1 Mcal/pulse
10	10 MJ/pulse	1 kWh/pulse	10 Mcal/pulse

Note: The pulses are output through the CMOS gate. Proper performance requires galvanically separated interfaces from Apator-Powogaz. Operating the pulse output in the test (fast) mode the maximum frequency of which is 64 Hz, will significantly increase the battery power consumption. If this operating mode is continuous, the battery life is reduced to approx. 1 year.

Note: The pulse generation method error in the energy or volume-proportional operating mode is +/- pulse. When verifying the resolver performance by the total of pulses at the output, choose the verification time (i.e. the number of pulses) to minimise the method error.

Example: The body is 0.6, the operating mode is volume proportional, and the flow Q_p is 600 dm^3/h . The recommended number of pulses for flow measurement accuracy verification is 500. Here the method error is 1/10 MPE i.e. 0.2 %, and the test will take approx. 30 seconds.

7.2. Wireless interface

KEY FEATURES

- Easy installation and removal.
- Installing the module does not tamper the heat meter verification markings.
- Wireless data transmission.
- Plug & play system.
- Remote readability at a range of up to 100 m.
- IP54 protection rating.



COMPLETE
MODULE ASSEMBLY
View from the
connection pins side



WIRELESS TRANS-
MITTER MODULE
(to be installed
in the enclosure)

Wireless module specifications		
Enclosure		Integrated with the heat meter main enclosure by 2 snap fasteners; electrical connection: 2x5 pin (2.54 mm matrix)
Antenna		Internal, wire type $\frac{1}{4} \lambda$
Power supply		Lithium battery, 3.6 V, 1200 mAh, size $\frac{1}{2}$ AA, installed in the wireless module enclosure, battery life: 5+1 years
Operating temperature range	°C	0 ÷ +55
Operating frequency	MHz	868.950
Frequency variation	kHz	< ± 2.5
Modulation		FSK, frequency deviation: ± 50 kHz
Transmitter power	dBm	10
Receiver sensitivity	dBm	-105
Mode		T1, data transmission period: 120 s
Transmitted registers		serial number, error flags, date, heat energy, main volume, supply temperature, return temperature, last month heat energy
Register refresh rate		900 s (the register refresh interval is the time at which the wireless module polls the heat meter for the register contents)

The available module versions are for installation in the enclosure and fully enclosed assemblies.

7.3. USB interface

The USB communication interface enables quick and easy readouts of data from the meter, and to configure the available parameters. The main advantage here is that the interface requires no additional transmission converters. See the separate operating manual for the instructions for driver installation and communication software setup.



USB module		
Enclosure		Integrated with the heat meter main enclosure by 2 snap fasteners; electrical connection: 2x5 pin (2.54 mm matrix)
Operating temperature range	°C	0 ÷ +55
Power supply		5V DC, directly from the USB interface port of the reader
Data transmission speed	b/s	300 to 9600
Communication connector type	-	USB, A
USB cable length	m	1,5

8. SHIPPING AND MOUNTING

Transport the heat meters only on fully enclosed vehicles and with protection against shifting and damage. Store the heat meters in unit packaging in dry, clean indoor areas above +5 °C and below 90% of relative humidity. The heat meter can be identified (traced) by the markings and technical data located on the enclosure label. The shipment addressee should inspect the condition of the parcel before unpacking the heat meter, especially:

- the condition of the packaging;
- completeness of the shipment;
- the types and versions against the order;
- the condition of the enclosure and its seals (see section 8.1).

The heat meters are delivered only as complete units with the sensor pair installed, where one sensor is installed in the flow transducer body and the other is installed in a suitable fitting (i.e. a tee joint or a valve) connected to the heat pipe.

The quick user manual must be enclosed with the product.

Check the heat meter for mechanical damage before installation. If any damage, missing parts or discrepancies against the specifications is found, send a claim for the affected unit.

The product must be installed in the heating system piping by a professional service and according to the design requirements of the building and of PN-EN 1434-6:2007.

Note the following:

1. The flow direction shown by the arrow on the flow transducer body must match the actual flow in the metering circuit.
2. The heat meter must be installed in the correct pipe (supply or return), as indicated on the sticker on the body.
 - a. If the heat meter is installed in the supply circuit, install the supply temperature sensor in the flow transducer body and the return sensor in the return line.
 - b. If the heat meter is in the return circuit, install the supply temperature sensor in the supply line and the return sensor in the flow transducer body.

3. Before installing the temperature sensor in a tee joint or a valve, check that the temperature sensor fitting meets the requirements for the sensor **seat depth** and that the **seat diameter** matches the sensor diameter. See the dimensions in Fig. 1 and 2.

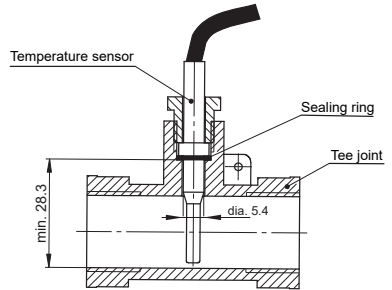
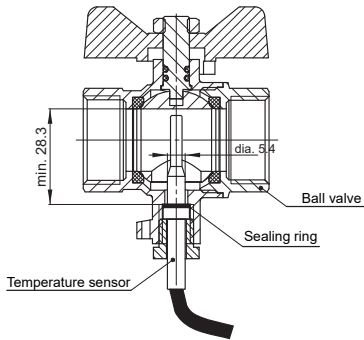

Fig. 1 Temperature sensor installed in a tee joint

Fig. 2 Temperature sensor installed in a ball valve

Note:

Using valves and pipe fittings that do not meet the requirements may damage the temperature sensor.

Seal the heat meter connections on both lines with the same sealing wire threaded through the holes in the threaded connections and through the special lug on the flow transducer body.

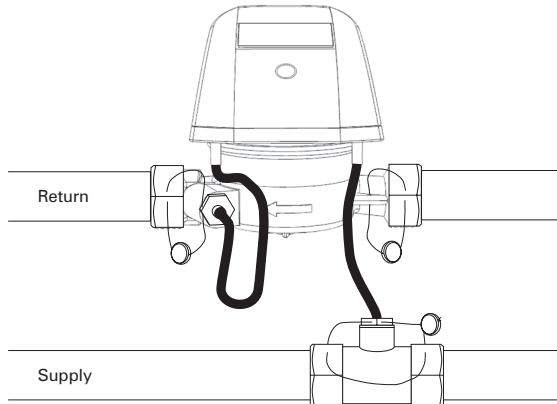

Fig. 3 Example installation and sealing of the heat meter on the return line.

8.1. Sealing

Elf heat meters are sealed with self-adhesive seals to prevent unauthorised access to the electronic circuit – see the figure below.

The enclosure base is sealed together with the enclosure with a sealing wire threaded through the holes in the band clip. Once closed, the complete enclosure is sealed with stickers made of a special film which brittles when peeled. The seals are located on the fastening screw and on the mating line between the base and the housing body.

The interface body is also sealed with a sticker – see section 7 and the respective figure. The technical service of the user is allowed to remove the sticker when installing the interfaces. Once the interfaces have been commissioned, it is recommended to apply a service seal or an Apator-Powogaz branded sticker. Seal the heat meter connections on both lines with the same sealing wire threaded through the holes in the threaded connections and through the special lug on the flow transducer body – see the figure in the previous section.

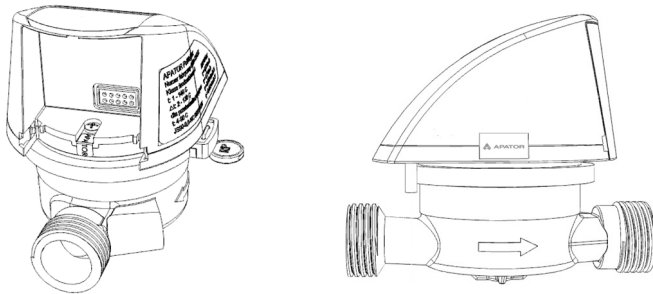

8.2. Electrical interference

Elf heat meters do not require special electrical interference protection; however, electromagnetic interference must be avoided. The sensor wiring must not lay directly at power cables, or other high-power electrical devices. Do not cut, extend or shorten the wires of measurement sensors. The wiring of additional pulse inputs must be as short as possible; the wire length of passive pulsers (dry with open collector) must not exceed 10 m – if extension is necessary, make it with an additional terminal strip located in a junction box.

If transmission network interfaces are used, especially when the wires are routed outside of the building, use increased protection against electrical interference. Detailed information is available from competent Apator-Powogaz personnel.

9. WARRANTY AND SERVICE

The reliable operation of heat meters is guaranteed for 12 months from the commissioning date, provided that operation will meet the requirements provided in this document. The warranty does not include damage caused by improper shipping or operation. The users rights from the warranty are void and null if unauthorised persons repair the product without permission of the manufacturer (by breaking the seals).

The warranty is void and null when the following is found:

- repairs made by personnel unauthorised to perform warranty service;
- unauthorised removal of seals;
- modifications and changes of design;
- installation or operation considered as unintended use in the user manual;
- mechanical damage to the resolver enclosure.

Elf heat meters self-diagnose by indication of error codes. Specific error codes are only displayed during an emergency/failure; if the error signal cause is removed, the error signal will be automatically reset. Example: water hammering may occur during opening or closing the flow, which cause error 32 – overflow; if the error signal is reset, there is no need to call the service. In the same way, error 2 is normal when the flow is actually isolated; however, service assistance will be necessary if the error code is not reset when the flow is opened, since it means a fault of the flow transducer has occurred. The following table presents the troubleshooting procedures for Elf.

Problem	Cause	Remedy
LCD blank, push-button non-responsive	The battery is dead or damaged	Bring the product to the manufacturer technical service
Error 4 or 8 persists	The corresponding temperature sensor has failed	Bring the product to the manufacturer technical service
The heat meter is suspected of under or overmetering	The intake filter of the flow transducer is clogged or undermetering is caused by incorrect installation of the temperature sensors	The heat provider service must make sure that the supply pipe is unobstructed and that the sensors have been properly installed; if both are not correct, bring the product to the manufacturer technical service
Error 2 present	The cut-off valve is closed	Open the valve
	The intake filter of the flow transducer is clogged	The heat provider service must make sure that the supply pipe is not clogged; if it is unobstructed and the error persists, bring the product to the manufacturer technical service
Error 16 present	The temperature sensors have been interchanged during installation	The heat provider technical service must interchange the sensor installation

9.1. Recommendations for end of life

The water meters are designed for five years of uninterrupted operation. Specific maintenance action is necessary for operation after this period. The minimum scope of maintenance is to replace the batteries and reassess the metrological performance.

The battery must be replaced by a qualified technician; it requires breaking the housing seals and soldering. Flow meter handling and disposal requirements are the same as for household water meters.

10. MARKING AND ORDERING GUIDELINE

10.1. Ordering the complete heat meter assembly

Product code:

6 5 - M J P P C I T - W W W

65 - Elf heat meter

M – installation location

- 0 return
- 1 supply

J – energy unit

- 0 GJ
- 1 kWh
- 2 Gcal

PP – transducer type

- 45 $q_p = 0,6 \text{ m}^3/\text{h}$, DN15
- 46 $q_p = 1,0 \text{ m}^3/\text{h}$, DN15
- 47 $q_p = 1,5 \text{ m}^3/\text{h}$, DN15
- 48 $q_p = 1,5 \text{ m}^3/\text{h}$, DN20
- 49 $q_p = 2,5 \text{ m}^3/\text{h}$, DN20

C – medium type

- 1 hot water 90°C

I – interface type

- 0 no interface
- 1 M-Bus + 4 pulse inputs
- 2 M-Bus + 2 pulse inputs + 1 pulse output
- 3 4 pulse inputs
- 4 3 pulse inputs + 1 pulse output
- 5 Wireless, 868 MHz

T – temperature sensor type

- 7 - TOPE 42 / 1 battery (as certified)
- 8 - TOPE 42 / 2 battery (as certified)

WWW – Design type

- 000 Basic MID design
- 001 Design for DAF Energy, Turkey
- 002 Design for ADUNOS IMS
- 003 Basic MID design, label in English
- 004 Basic MID design, label in Hungarian

-
- 980 Design for Russia
 - 982 Design for MessTechnik
 - 983 Design for Ukraine
 - 985 Design for GranSystema Belarus

-
- 999 Design

Example order code: 65-0045107-000 - Elf return, GJ, $q_p = 0.6 \text{ m}^3/\text{h}$, DN15, no interface, Basic MID version

10.2. Ordering the communication modules

0949-500-090 Elf interface enclosure, empty
0949-500-091 Elf MBUS interface + 4 pulse inputs
0949-500-092 Elf MBUS interface + 2 pulse inputs + 1 pulse output
0949-500-093 Elf MBUS interface + 4 pulse inputs
0949-500-094 Elf MBUS interface + 3 pulse inputs + 1 pulse output
0949-290-045 Elf Wireless 868 interface
0949-500-037 Elf USB interface

Each interface is delivered in the enclosure.

Ordering example: 0949-500-091 - Elf MBUS interface + 4 pulse inputs

11. ANNEXES

Annex A. Display in the basic operating mode.

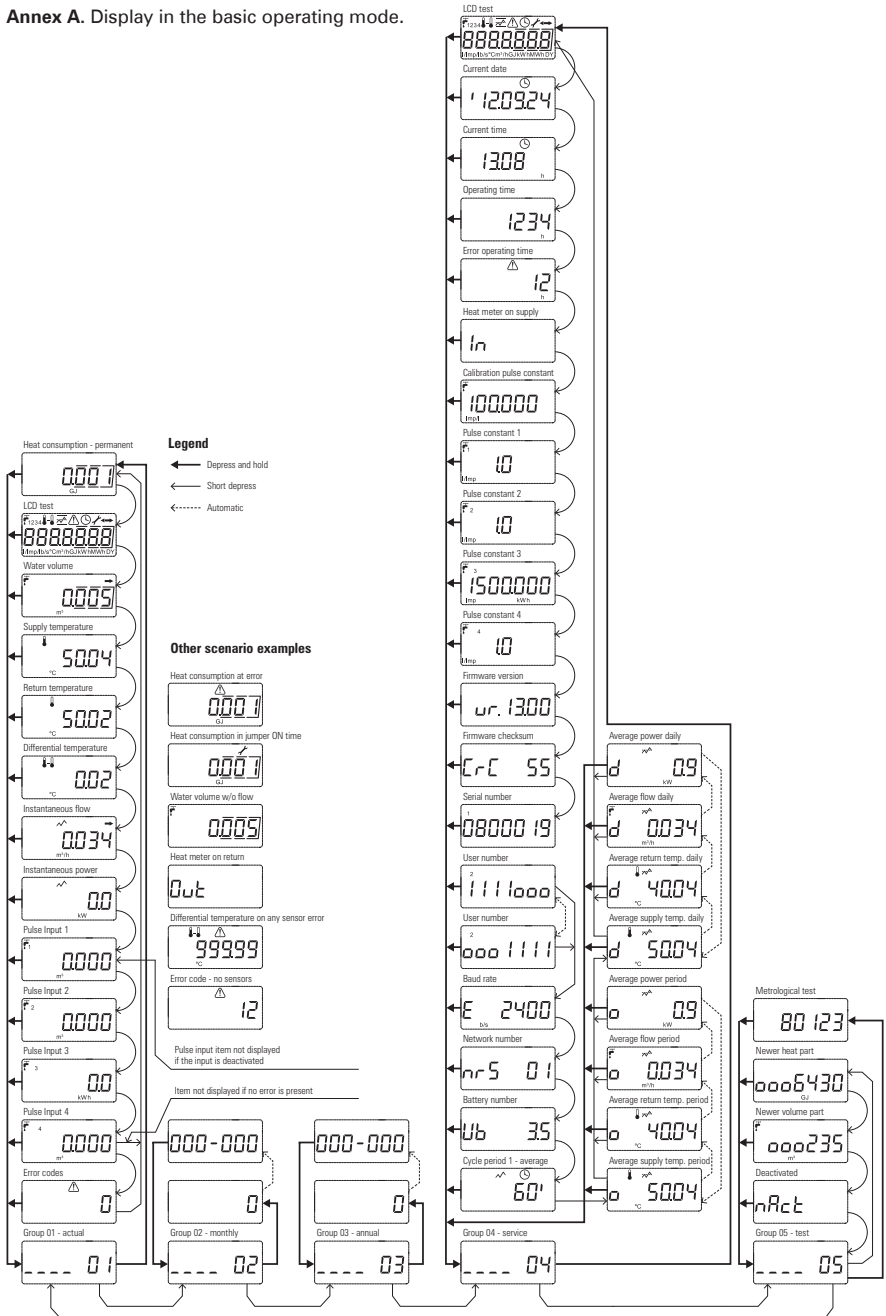

Annex B. Display of data recorded in cycle 3 and 4.

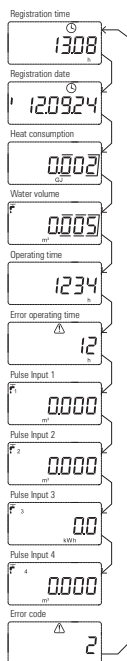

The data cycles automatically every 2 seconds. Pressing the push-button switches to the next registration display

ENVIRONMENTAL NOTICE

Do not dispose of with regular waste/trash. Bring the product to a specialist collection point for disposal. You will help protect the natural environment.

