

RA
switch disconnectors

RAB
switch disconnectors fuses

- RA switch disconnectors and RAB switch disconnectors fuses are designed for distribution of electricity, making and breaking currents and protection of electrical equipment against shortcircuits and overloads with industrial fuse links.



RA100P3/OHB
+cable terminal shrouds

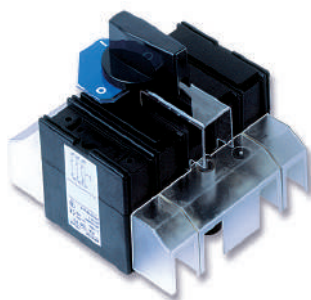

RA100P3/R
+cable terminal shrouds



RAB1P3/OHY
+fuse link shroud



RAB2P3/OHY
+fuse link shroud

R type series is divided into two groups:

- RA switch disconnectors
 - 3-pole with optional neutral (N) 4th pole
 - RA100 - 4th pole switchable
- RAB switch disconnectors fuses
 - 3-pole with optional neutral (N) 4th pole
 - RAB000 - 4th pole switchable

GENERAL INFORMATION

- safety of service and easy installation,
- self-extinguishing thermoplastics (VO flammability class),
- silver plated parts of current circuits,
- self-tightening and self-cleaning contacts,
- high electrical and mechanical endurance,
- high short-circuit making and breaking capacity,
- double, safe clearance between open contacts,
- complete isolation of fuse links in „off” position,
- manually operated drive (spring powered),
- wide range of accessories.

APPLICATIONS

Switch disconnectors series **R** are designed for distribution of electricity and protection against short circuits and overloads in three phase alternative current circuits. They can be used as:

- main switch disconnector in distribution boards,
- switch disconnector,
- switch disconnector for motor control and protection.

OPERATING CONDITIONS

- to be installed in the room free of any dust, aggressive or explosive gases,
- for moderate, marine and tropical climate,
- ambient temperature from -25°C to +55°C,
- altitude up to 2000 meters above sea level,
- outdoor – in cabinets with protection degree > IP 34.

CONSTRUCTION AND OPERATION

RA switch disconnectors and **RAB** switch disconnectors fuses consists of following parts:

- bottom part of the body with fitted current circuits (stationary contacts, cable terminals)
- top part of the body with fitted contacts (**RA**) or spring loaded contacts for fuse link blades (**RAB**)
- traverse with moving contacts
- manually operated drive (spring powered)

Current circuit of each phase has four clearances between contacts in switched off position(double clearance for each pair of contacts, two pairs of contacts for each phase phase) ensuring required isolating distance and safe replacement of fuse links in **RAB** switch disconnectors fuses. Manually triggered, springpowered drive delivers rapid switching. **RA** switch disconnectors and **RAB** switch disconnectors fuses can be equipped with two types of handles:

- R type - installed on disconnector's shaft
- OHB, OHY type - for installation on distribution board's door

Handle position indicates disconnector's state - switched on or switched off. OHB and OHY handles are designed for locking by up to three padlocks in OFF („O”) position. Handles are available in colours black and yellow-red. Wide range of accesories is available for **RA** switch disconnectors and **RAB** switch disconnectors fuses like additional shafts, shaft joints, auxiliary switches, cable terminal shrouds, fuse link shrouds, etc.

INSTALLATION

RA switch disconnectors and **RAB** switch disconnectors fuses are designed for operation in horizontal or vertical position with permissible deviation of 30° in any direction. **RA** switch disconnectors and **RAB** switch disconnectors fuses should be mounted to support structure with screws with spring washers.

Table 112. Screw terminals tightening torque

Screw	M6	M8	M10	M12
Tightening torque	7 Nm	14 Nm	24 Nm	38 Nm

Table 113. RA technical data

Article	Unit	RA 100	RA 160	RA 250	RA 400	RA 630	RA 1250
Parameter		Value					
Rated thermal current	I_{th} A	100	160	250	400	630	1250
Rated insulation voltage	U_i V	1000					
Rated impulse withstand voltage	U_{imp} kV	8					
Rated frequency	Hz	50 ÷ 60					
Rated switching current for AC 22A $U_e = 690$ V	I_e A	100	125	125	250	400	-
Rated switching current for AC 22B $U_e = 690$ V	I_e A	-	-	-	400	630	-
Rated switching current for AC 22A $U_e = 500$ V	I_e A	-	-	-	-	-	1250
Rated switching current for AC 22B $U_e = 415$ V	I_e A	-	-	250	-	-	-
Rated switching current for AC 23A $U_e = 500$ V	I_e A		160	160	-	-	-
Rated switching current for AC 23A $U_e = 690$ V	I_e A	40	-	-	-	-	-
Rated short-circuit making capacity	I_{cm} kA _{max}	7	9	20	25	35	100
Rated short-time withstand current 1 s	I_{cw} kA	2,5	8	8	15	15	50
Mechanical durability	number of cycles	10000	8000	8000	5000	5000	3000
Electrical durability at utilization category AC 22 A		1500	1000	1000	1000	1000	500
Duty	-	Continuous duty					
Protection degree IP	-	IP 00					
Weight	kg	0,95	1,7	1,85	3,3	4,3	12,5
Busbar cross-section	mm ²	15 x 2	20 x 4	25 x 4	2 x 25 x 4	2 x 30 x 5	60 x 10
Cable conductor cross-section	mm ²	35	95	120	240	2 x 185	-

Table 114. RA switch disconnectors with standard cable terminals

Type	I _n	Number of poles	Accessories*	Article	Article No.
RA 100	100 A	3	-	RA 100 P3	on request
		3 + N	-	RA 100 P3 N	63-823064-091
		4	-	RA 100 P4	on request
		3	R1	RA 100 P3/R	on request
		3 + N	R1	RA 100 P3 N/R	63-823064-211
RA 160	160 A	4	R1	RA 100 P4/R	on request
		3	-	RA 160 P3	63-822982-011
		3 + N	-	RA 160 P3 N	on request
RA 160	160 A	3	R1	RA 160 P3/R	63-822982-051
		3 + N	R1	RA 160 P3 N/R	on request
		3	-	RA 250 P3	63-822982-021
RA 250	250 A	3 + N	-	RA 250 P3 N	on request
		3	R1	RA 250 P3/R	63-822982-061
		3 + N	R1	RA 250 P3 N/R	on request
RA 400	400 A	3	-	RA 400 P3	63-811593-011
		3 + N	-	RA 400 P3 N	on request
		3	R1	RA 400 P3/R	63-811593-051
RA 400	400 A	3 + N	R1	RA 400 P3 N/R	on request
		3	-	RA 630 P3	63-811593-021
		3 + N	-	RA 630 P3 N	on request
RA 630	630 A	3	R1	RA 630 P3/R	63-811593-061
		3 + N	R1	RA 630 P3 N/R	on request
		3	-	RA 1250 P3	63-811601-011
RA 1250	1250 A	3 + N	-	RA 1250 P3 N	63-811601-021
		3	R1	RA 1250 P3/R	63-811601-031
		3 + N	R1	RA 1250 P3 N/R	63-811601-041

* R1 - handle mounted on shaft

CAUTION! N - 4th pole unswitchable, switchable 4th pole available only for RA100 type switch disconnectors

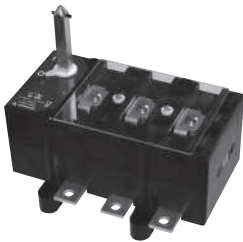
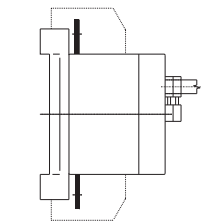

RA 100 P3



RA 100 P3/R

Table 115. RA switch disconnectors with „A” type cable terminals

Type	I _n	Number of poles	Accessories*	Article	Article No.
RA 100	100 A	3	-	RA 100 P3 A	63-823064-021
		3 + N	-	RA 100 P3 NA	63-823064-101
		4	-	RA 100 P4 A	63-823064-061
		3	R1	RA 100 P3 A/R	63-823064-141
		3 + N	R1	RA 100 P3 NA/R	63-823064-221
RA 160	160 A	4	R1	RA 100 P4 A/R	63-823064-181
		3	-	RA 160 P3 A	63-823165-011
		3 + N	-	RA 160 P3 NA	63-823165-021
RA 160	160 A	3	R1	RA 160 P3 A/R	63-823165-131
		3 + N	R1	RA 160 P3 NA/R	63-823165-141
		3	-	RA 250 P3 A	63-823165-031
RA 250	250 A	3 + N	-	RA 250 P3 NA	63-823165-041
		3	R1	RA 250 P3 A/R	63-823165-151
		3 + N	R1	RA 250 P3 NA/R	63-823165-161
RA 400	400 A	3	-	RA 400 P3 A	63-811618-011
		3 + N	-	RA 400 P3 NA	63-811618-031
		3	R1	RA 400 P3 A/R	63-811618-131
RA 400	400 A	3 + N	R1	RA 400 P3 NA/R	63-811618-151
		3	-	RA 630 P3 A	63-811618-021
		3 + N	-	RA 630 P3 NA	63-811618-041
RA 630	630 A	3	R1	RA 630 P3 A/R	63-811618-141
		3 + N	R1	RA 630 P3 NA/R	63-811618-161

* R1 - handle mounted on shaft

A

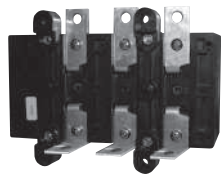
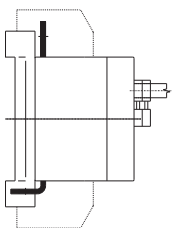

RA 250 P3 A

Table 116. RA switch disconnectors with „B” type cable terminals

Type	I _n	Number of poles	Accessories*	Article	Article No.
RA 100	100 A	3	-	RA 100 P3 B	63-823064-031
		3 + N	-	RA 100 P3 NB	63-823064-111
		4	-	RA 100 P4 B	63-826064-071
		3	R1	RA 100 P3 B/R	63-823064-151
		3 + N	R1	RA 100 P3 NB/R	63-823064-231
		4	R1	RA 100 P4 B/R	63-823064-191
RA 160	160 A	3	-	RA 160 P3 B	63-823165-051
		3 + N	-	RA 160 P3 NB	63-823165-061
		3	R1	RA 160 P3 B/R	63-823165-171
		3 + N	R1	RA 160 P3 NB/R	63-823165-181
RA 250	250 A	3	-	RA 250 P3 B	63-823165-071
		3 + N	-	RA 250 P3 NB	63-823165-081
		3	R1	RA 250 P3 B/R	63-823165-191
RA 400	400 A	3 + N	R1	RA 250 P3 NB/R	63-823165-201
		3	-	RA 400 P3 B	63-811618-051
		3 + N	-	RA 400 P3 NB	63-811618-071
RA 630	630 A	3	R1	RA 400 P3 B/R	63-811618-171
		3 + N	R1	RA 400 P3 NB/R	63-811618-191
		3	-	RA 630 P3 B	63-811618-061
		3 + N	-	RA 630 P3 NB	63-811618-081
RA 630	630 A	3	R1	RA 630 P3 B/R	63-811618-181
		3 + N	R1	RA 630 P3 NB/R	63-811618-201

* R1 - handle mounted on shaft

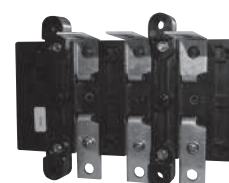
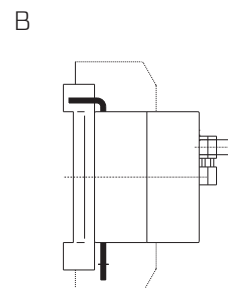

RA 250 P3 B

Table 117. RA switch disconnectors with „C” type cable terminals

Type	I _n	Number of poles	Accessories*	Article	Article No.
RA 100	100 A	3	-	RA 100 P3 C	63-823064-041
		3 + N	-	RA 100 P3 NC	63-823064-121
		4	-	RA 100 P4 C	63-823064-081
		3	R1	RA 100 P3 C/R	63-823064-161
		3 + N	R1	RA 100 P3 NC/R	63-823064-241
		4	R1	RA 100 P4 C/R	63-823064-201
RA 160	160 A	3	-	RA 160 P3 C	63-823165-091
		3 + N	-	RA 160 P3 NC	63-823165-101
		3	R1	RA 160 P3 C/R	63-823165-211
RA 250	250 A	3 + N	R1	RA 160 P3 NC/R	63-823165-221
		3	-	RA 250 P3 C	63-823165-111
		3 + N	-	RA 250 P3 NC	63-823165-121
RA 400	400 A	3	R1	RA 250 P3 C/R	63-823165-231
		3 + N	R1	RA 250 P3 NC/R	63-823165-241
		3	-	RA 400 P3 C	63-811618-091
RA 630	630 A	3 + N	-	RA 400 P3 NC	63-811618-111
		3	R1	RA 400 P3 C/R	63-811618-211
		3 + N	R1	RA 400 P3 NC/R	63-811618-231
		3	-	RA 630 P3 C	63-811618-101
RA 630	630 A	3 + N	-	RA 630 P3 NC	63-811618-121
		3	R1	RA 630 P3 C/R	63-811618-221
		3 + N	R1	RA 630 P3 NC/R	63-811618-241

* R1 - handle mounted on shaft

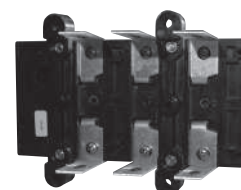
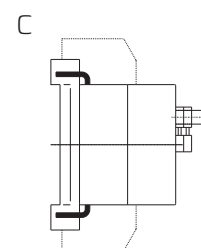

RA 250 P3 C

Dimensions of RA100

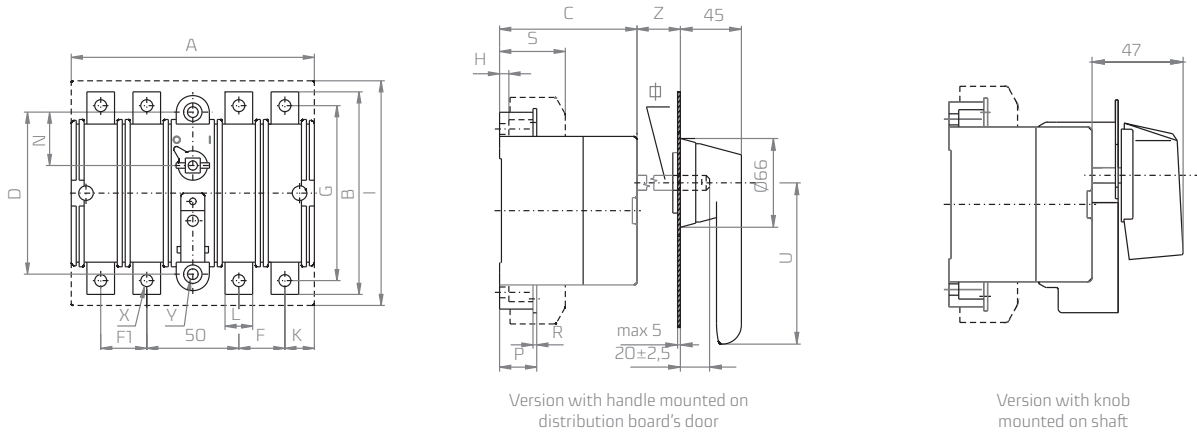

Dimension [mm]	A	B	C	D	E	F	F1	G	H	I	K	L	L1	M	N	O	P	R	S	U	X	Y	Z	∅	W
RA 100	132	110	74	88	-	25	25	95	5	150	16	15	-	-	29	-	20	2	50	65	6,5	5,8	20	8	-

Dimensions of RA 160, RA 250, RA 400, RA 630

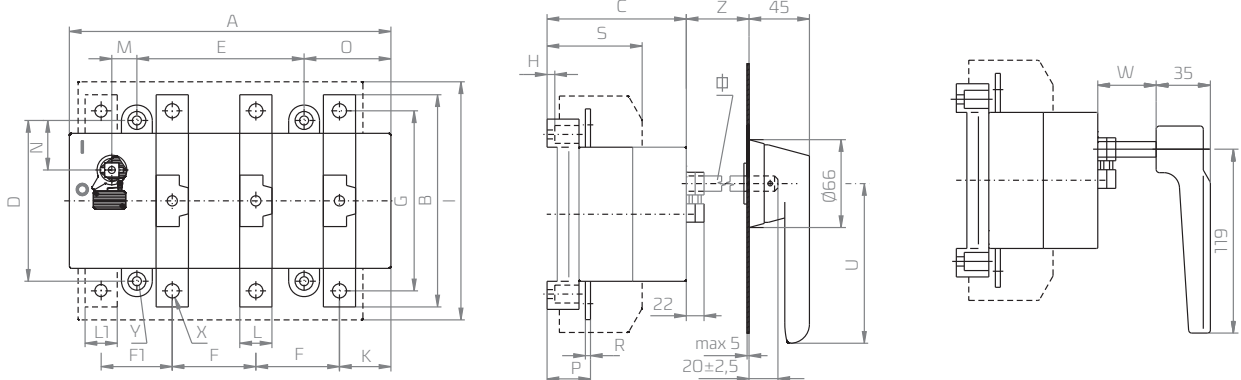

Dimension [mm]	A	B	C	D	E	F	F1	G	H	I	K	L	L1	M	N	O	P	R	S	U	X	Y	Z	∅	W
RA 160																		3							
RA 250	176	132	88	110	84	42	42	115	5	170	30	20	20	16	36	51	26	3,5	61	95	8,8	5,8	43	10	32
RA 400																		34							
RA 630	250	174	109	125	130	65	55	149	8	225	40	25	25	20	38,5	67,5	30	4	86	125	11	7	47	12	32

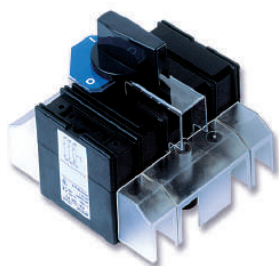

RA 100 P3/R
with additional terminal shroud

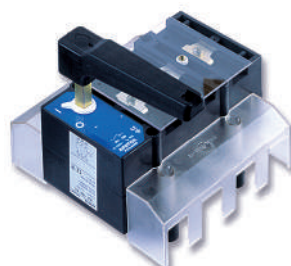

RA 160 P3/R
with additional terminal shroud



RA 160 P3/OHB
with additional terminal shroud

CABLE TERMINALS OF TYPE A, B, C

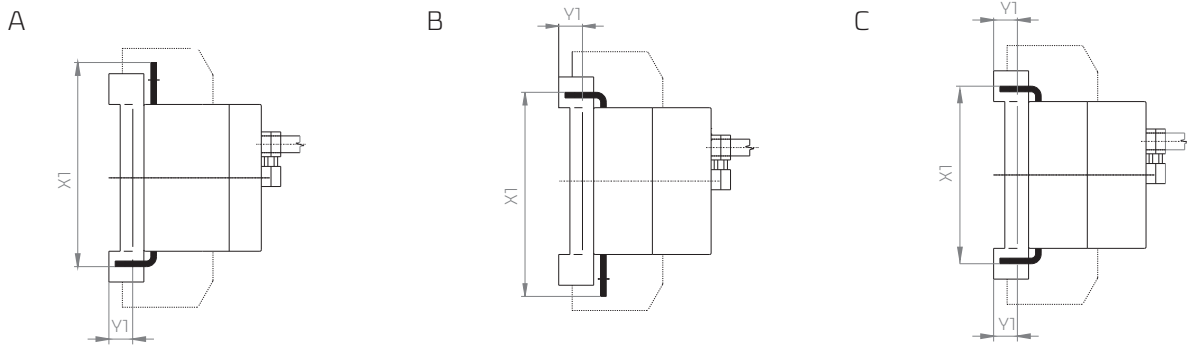

Dimensions of cable terminals [mm]	RA 160			RA 250			RA 400			RA 630		
	A	B	C	A	B	C	A	B	C	A	B	C
X1	111	111	90	111	111	90	140,5	140,5	116	146	146	127
Y1	8,5	8,5	8,5	8,5	8,5	8,5	13	13	13	13	13	13

Dimensions of RA1250

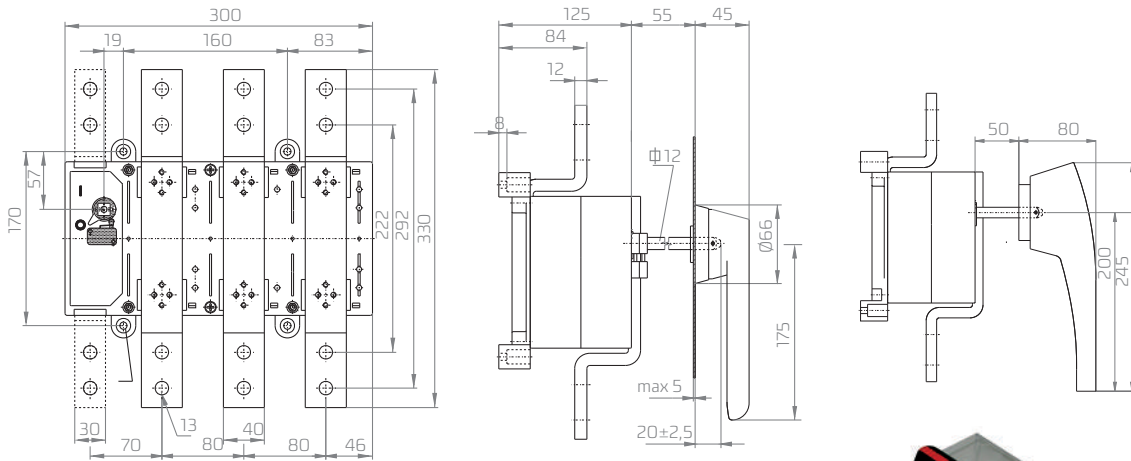

RA 1250 P3/OHB

For installation behind assembly panel
RA 160/250

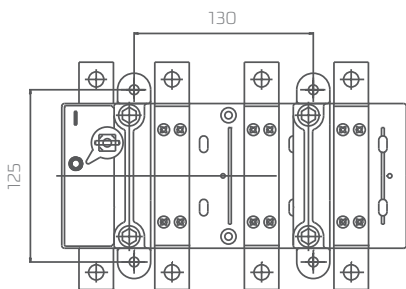

RA 400/630

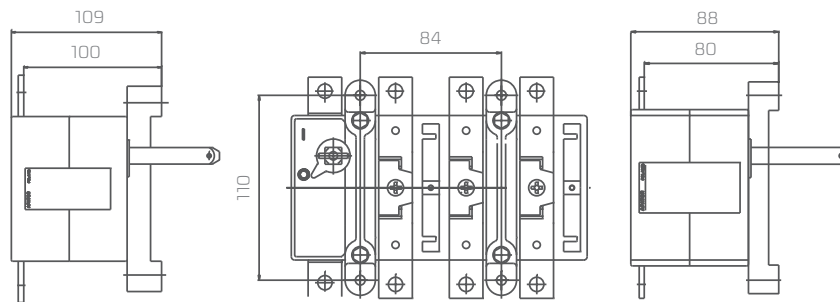

CAUTION!
lengthening of shaft is possible by adding second shaft,
connected by shaft link (see Accessories)

CHANGE-OVER SWITCHES I-O-II



2 x RA 160 P3

I - O - II	Poles	I _n	Article No. of RA switch	Article No. of coupling mechanism	
				handle mounted on shaft	handle OHB mounted on distribution board's door
160	3	160 A	2 x RA 160 P3 (63-822982-011)	+63-839949-011	+63-839949-021
250	3	250 A	2 x RA 250 P3 (63-822982-021)	+63-839949-011	+63-839949-021
400	3	400 A	2 x RA 400 P3 (63-811593-011)	+63-839972-011	+63-839972-021
630	3	630 A	2 x RA 630 P3 (63-811593-021)	+63-839972-011	+63-839972-021
1250	3	1250 A	2 x RA 1250 P3 (63-811601-011)	+63-930893-011	+63-930893-021

Dimensions of change-over switch I-O-II

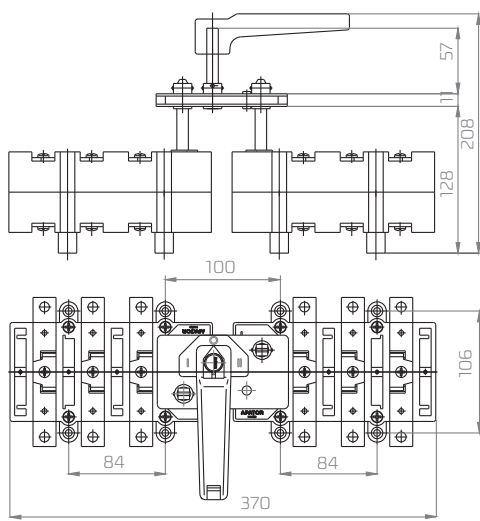

160 A - 250 A

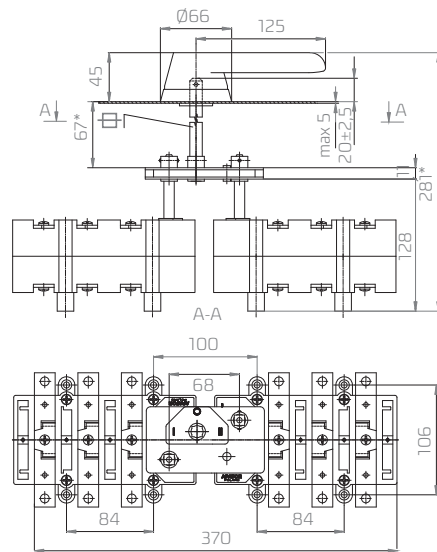

160 A - 250 A

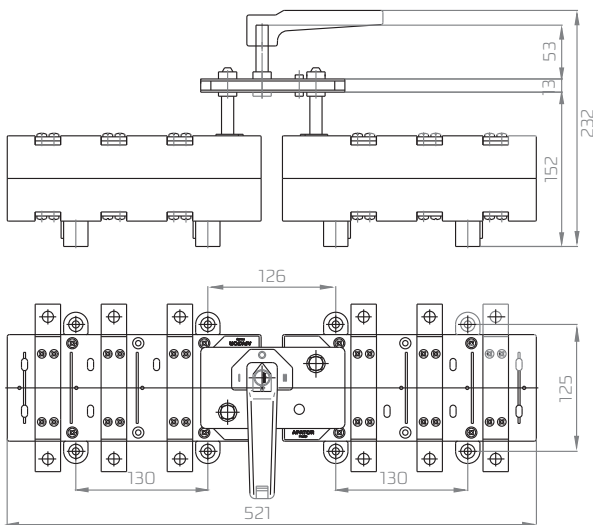

400 A - 630 A

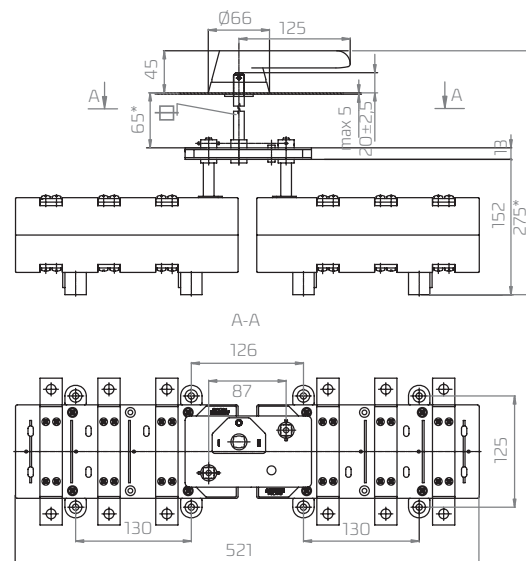

400 A - 630 A

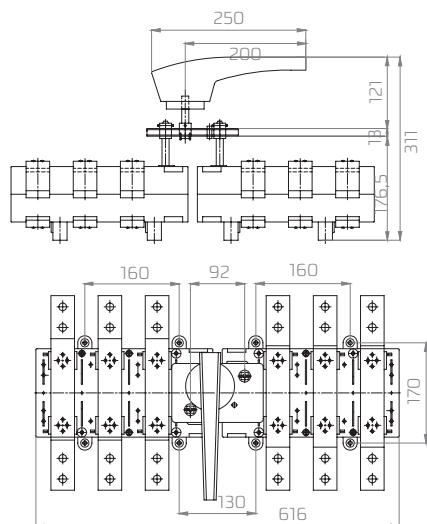

1250 A
handle mounted on shaft

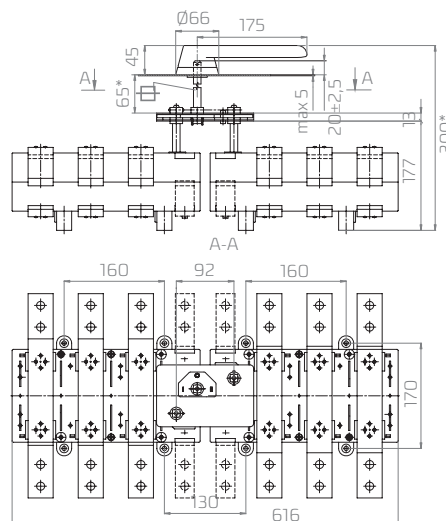

1250 A
handle mounted on distribution board's door

Enclosures for RA type switch disconnectors	Order No.	
	ENSTO	HENSEL
For RA 100..., RAB 000...		
Enclosure with gray cover	OABP 203013 G	Mi 80101
Enclosure with transparent cover	OABP 203013 T	Mi 80100
Mounting plate	OMP 2030	
Distance parts	OELA 1.04	
Mounting plate	OMP 2030	
Distance parts	OELA 1.04	
For RA 160..., 250...		
Enclosure with gray cover	OABP 303018 G	Mi 80201
Enclosure with transparent cover	OABP 303018 T	Mi 80200
Mounting plate	OMP 3030	
Distance parts	OELA 1.04	
For RA 400..., 630...		
Enclosure with gray cover	OABP 304018 G	Mi 80211
Enclosure with transparent cover	OABP 304018 T	Mi 80210
Mounting plate	OMP 3040	
Distance parts	OELA 1.04	

* R1 handle mounted on shaft

L-minimal distance between shaft and door's hinge



hole in enclosure's cover for mounting of OHB handles

mounting position of shaft and shaft's pin

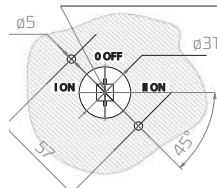

Switch disconnector	Length [mm]	Handle
RA 100	80	OH...65 J8
RAB 000		
RA 160/250	120	OH...95 J10
RAB 00		
RA 400/630		
RAB 1/2	150	OH...125 J12
RAB 3	200	OH...145 J12
RA 1250	200	OH...175 J12

RAB switch disconnectors fuses

Table 118. RAB technical data

Article	Unit	RAB 000	RAB 00	RAB 1	RAB 2	RAB 3
Parameter		Value				
Rated thermal current	I_{th} A	100	160	250	400	630
Rated insulation voltage	U_i V	1000				
Rated impulse withstand voltage	U_{imp} kV	8				
Rated frequency	Hz	50 ÷ 60				
Rated switching current for AC 22A $U_e = 690$ V	I_e A	100	125	250	400	-
Rated switching current for AC 22B $U_e = 690$ V	I_e A	-	-	-	-	630
Rated switching current for AC 23A $U_e = 690$ V	I_e A	40	-	-	-	-
Rated switching current for AC 23A $U_e = 500$ V	I_e A	-	160	-	-	-
Rated switching current for AC 23A $U_e = 415$ V	I_e A	-	-	-	-	630
Rated power dissipation	W	7,5	12	32	45	60
Fused short-circuit current $I_n = I_{th}$	kA	100				
Mechanical durability	number of cycles	10000	8000	8000	5000	5000
Electrical durability at utilization category AC 22 A	number of cycles	1500	1000	1000	1000	1000
Duty	-	Praca ciągła				
Protection degree IP	-	IP 00				
Weight	kg	1,05	2,0	3,65	4,2	7,5
Busbar cross-section	mm ²	15 x 2	25 x 4	2 x 25 x 4	2 x 30 x 5	2 x 40 x 60
Cable conductor cross-section	mm ²	35	120	240	2 x 185	-

Table 119. RAB switch disconnectors fuses with standard cable terminals

Type	I_n	Number of poles	Accessories*	Article	Article No.
RAB 000	100 A	3	-	RAB 000 P3	on request
		3 + N	-	RAB 000 P3 N	on request
		4	-	RAB 000 P4	63-823063-051
		3	R1	RAB 000 P3/R	on request
		3 + N	R1	RAB 000 P3 N/R	on request
RAB 00	160 A	4	R1	RAB 000 P4/R	on request
		3	-	RAB 00 P3	on request
		3 + N	-	RAB 00 P3 N	on request
		3	R1	RAB 00 P3/R	on request
RAB 1	250 A	3 + N	R1	RAB 00 P3 N/R	on request
		3	-	RAB 1 P3	on request
		3 + N	-	RAB 1 P3 N	on request
RAB 2	400 A	3	R1	RAB 1 P3/R	on request
		3 + N	R1	RAB 1 P3 N/R	on request
		3	-	RAB 2 P3	on request
		3 + N	-	RAB 2 P3 N	on request
RAB 3	630 A	3	R1	RAB 2 P3/R	63-811529-061
		3 + N	R1	RAB 2 P3 N/R	on request
		3	-	RAB 3 P3	on request
RAB 3	630 A	3 + N	-	RAB 3 P3 N	on request
		3	R1	RAB 3 P3/R	63-811564-031
		3 + N	R1	RAB 3 P3 N/R	on request

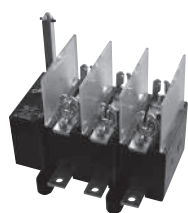
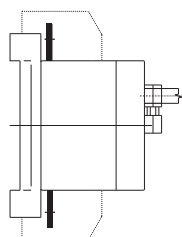

RAB 00 P3

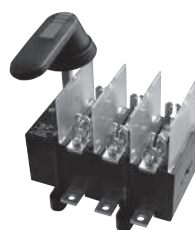

RAB 00 P3/OHB

*R1 - handle mounted on shaft

CAUTION!

N - 4th pole unswitchable, switchable 4th pole available only for RA100 type switch disconnectors!

Table 120. RAB switch disconnectors fuses with „A” type cable terminals

Type	I _n	Number of poles	Accessories*	Article	Article No.
RAB 000	100 A	3	-	RAB 000 P3 A	kofigurator
		3 + N	-	RAB 000 P3 NA	63-823063-101
		4	-	RAB 000 P4 A	63-823063-061
		3	R1	RAB 000 P3 A/R	on request
		3 + N	R1	RAB 000 P3 NA/R	on request
		4	R1	RAB 000 P4 A/R	on request
RAB 00	160 A	3	-	RAB 00 P3 A	on request
		3 + N	-	RAB 00 P3 NA	on request
		3	R1	RAB 00 P3 A/R	on request
		3 + N	R1	RAB 00 P3 NA/R	on request
RAB 1	250 A	3	-	RAB 1 P3 A	on request
		3 + N	-	RAB 1 P3 NA	on request
		3	R1	RAB 1 P3 A/R	on request
		3 + N	R1	RAB 1 P3 NA/R	on request
RAB 2	400 A	3	-	RAB 2 P3 A	on request
		3 + N	-	RAB 2 P3 NA	on request
		3	R1	RAB 2 P3 A/R	on request
		3 + N	R1	RAB 2 P3 NA/R	on request
RAB 3	630 A	3	-	RAB 3 P3 A	on request
		3 + N	-	RAB 3 P3 NA	on request
		3	R1	RAB 3 P3 A/R	on request
		3 + N	R1	RAB 3 P3 NA/R	on request

*R1 - handle mounted on shaft

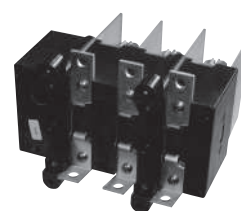
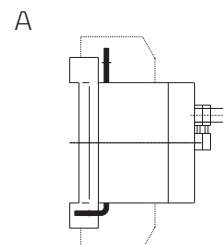

RAB 00 P3 A

Table 121. RAB switch disconnectors fuses with „B” type cable terminals

Type	I _n	Number of poles	Accessories*	Article	Article No.
RAB 000	100 A	3	-	RAB 000 P3 B	on request
		3 + N	-	RAB 000 P3 NB	63-823063-111
		3 + N	-	RAB 000 P4 B	63-823063-071
		3	R1	RAB 000 P3 B/R	on request
		3 + N	R1	RAB 000 P3 NB/R	on request
		4	R1	RAB 000 P4 B/R	on request
RAB 00	160 A	3	-	RAB 00 P3 B	on request
		3 + N	-	RAB 00 P3 NB	on request
		3	R1	RAB 00 P3 B/R	on request
		3 + N	R1	RAB 00 P3 NB/R	on request
RAB 1	250 A	3	-	RAB 1 P3 B	on request
		3 + N	-	RAB 1 P3 NB	on request
		3	R1	RAB 1 P3 B/R	on request
		3 + N	R1	RAB 1 P3 NB/R	on request
RAB 2	400 A	3	-	RAB 2 P3 B	on request
		3 + N	-	RAB 2 P3 NB	on request
		3	R1	RAB 2 P3 B/R	on request
		3 + N	R1	RAB 2 P3 NB/R	on request
RAB 3	630 A	3	-	RAB 3 P3 B	on request
		3 + N	-	RAB 3 P3 NB	on request
		3	R1	RAB 3 P3 B/R	on request
		3 + N	R1	RAB 3 P3 NB/R	on request

*R1 - handle mounted on shaft

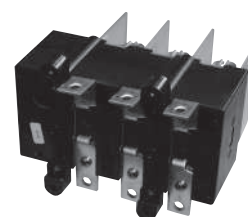
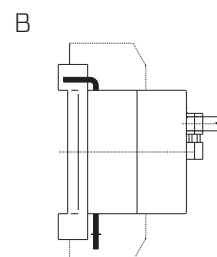

RAB 00 P3 B

Table 122. RAB switch disconnectors fuses with „C” type cable terminals

C

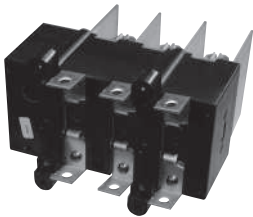
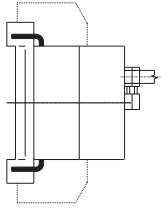

RAB 00 P3 C

Type	I _n	Number of poles	Accessories*	Article	Article No.
RAB 000	100 A	3	-	RAB 000 P3 C	63-823063-041
		3 + N	-	RAB 000 P3 NC	63-823063-121
		4	-	RAB 000 P4 C	63-823063-081
		3	R1	RAB 000 P3 C/R	on request
		3 + N	R1	RAB 000 P3 NC/R	on request
RAB 00	160 A	4	R1	RAB 000 P4 C/R	on request
		3	-	RAB 00 P3 C	on request
		3 + N	-	RAB 00 P3 NC	on request
RAB 00	160 A	3	R1	RAB 00 P3 C/R	on request
		3 + N	R1	RAB 00 P3 NC/R	on request
		3	-	RAB 1 P3 C	on request
RAB 1	250 A	3 + N	-	RAB 1 P3 NC	on request
		3	R1	RAB 1 P3 C/R	on request
		3 + N	R1	RAB 1 P3 NC/R	on request
RAB 2	400 A	3	-	RAB 2 P3 C	on request
		3 + N	-	RAB 2 P3 NC	on request
		3	R1	RAB 2 P3 C/R	on request
		3 + N	R1	RAB 2 P3 NC/R	on request
RAB 3	630 A	3	-	RAB 3 P3 C	on request
		3 + N	-	RAB 3 P3 NC	on request
		3	R1	RAB 3 P3 C/R	on request
		3 + N	R1	RAB 3 P3 NC/R	on request

*R1 - handle mounted on shaft

Dimensions of RAB 000 (100 A)

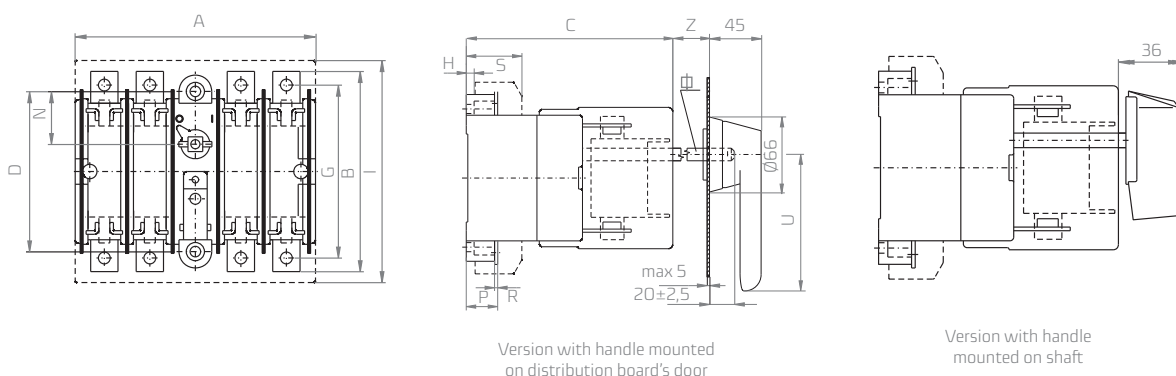

Dimension [mm]	A	B	C	D	E	G	H	I	L	M	N	O	P	R	S	U	Z	Ø	W
RAB 000	132	110	132	88	-	95	5	150	-	-	29	-	20	2	50	65	20	8	-

Dimensions of RAB 00, RAB 1, RAB 2, RAB 3

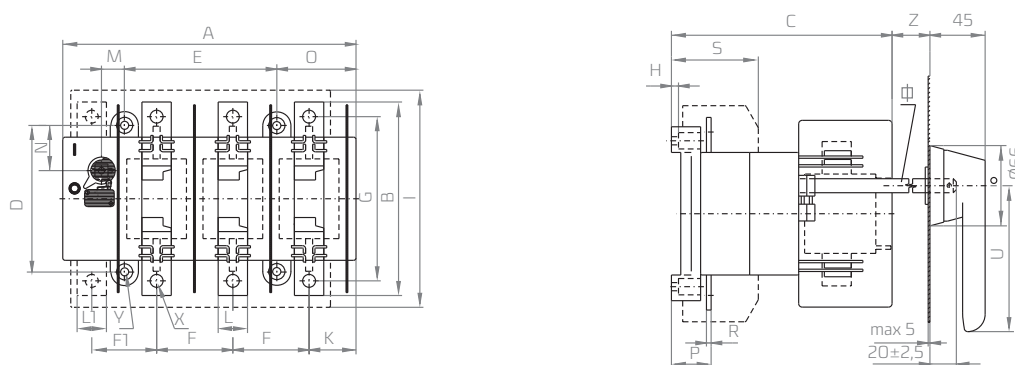

Dimension [mm]	A	B	C	D	E	F	FI	G	H	I	K	L	LI	M	N	O	P	R	S	U	X	Y	Z	Ø	W
RAB 00	176	132	150	110	84	42	42	115	5	170	30	20	20	16	36	51	26	3,5	61	95	8,5	5,8	15	10	20
RAB 1																	34	4							
RAB 2	250	174	189	125	130	65	55	149	8	225	40	25	25	20	38,5	67,5	30	5	86	125	11	7	15	12	25
RAB 3	300	240	215	170	160	80	70	200	8	270	45,5	40	30	19	56,5	83	40	6	97	145	13	7	20	12	-

Cable terminals of type A, B, C

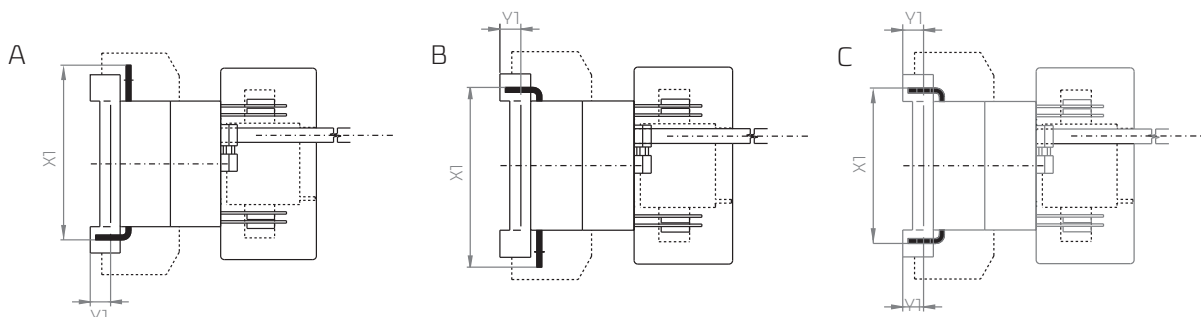

Dimensions of cable terminals [mm]	RAB 00			RAB 1			RAB 2		
	A	B	C	A	B	C	A	B	C
X1	111	111	90	140,5	140,5	116	146	146	127
Y1	8,5	8,5	8,5	8,5	8,5	8,5	13	13	13

CAUTION!
lengthening of shaft is possible by adding second shaft, connected by shaft link (see Accessories)

Dimensions of RA switch disconnectors, RAB switch disconnectors fuses (with cable terminals of type A, B, C) with side support element for mounting

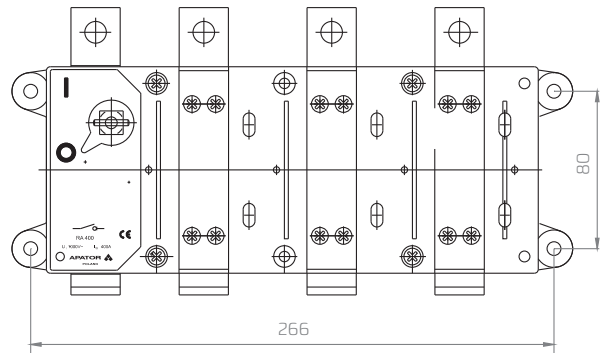
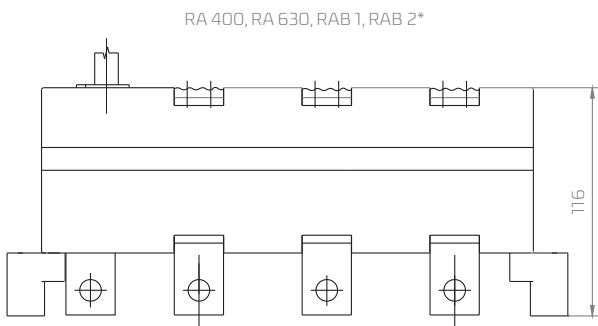
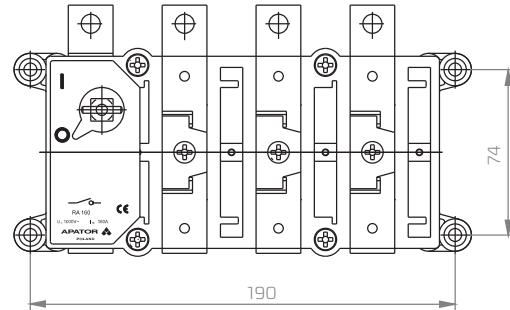
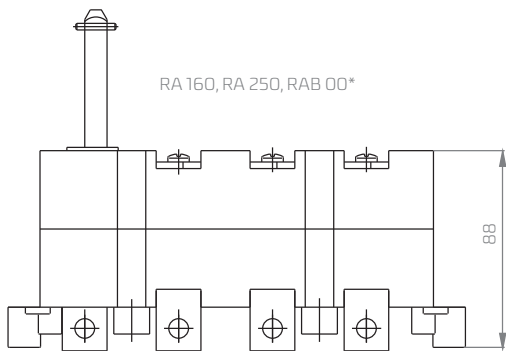

* ordered with switch

L-minimal distance between shaft and door's hinge

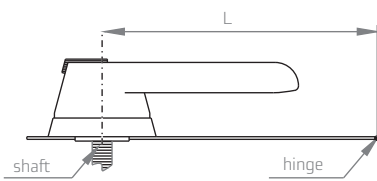

hole in enclosure's cover or door for mounting of OHB handles

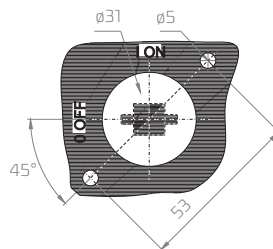

Switch disconnector	Length [mm]	Handle
RA 100	80	OH...65 J8
RAB 000	80	OH...65 J8
RA 160/250	120	OH...95 J10
RAB 00	120	OH...95 J10
RA 400/630	150	OH...125 J12
RAB 1/2	150	OH...125 J12
RAB 3	200	OH...145 J12
RA 1250	200	OH...175 J12

Fuse link shrouds

Article No.	For use with switch of type	Number of shrouds mounted on switch	Number of shrouds in package	Additional informations
53-944921-011	RAB 000	1	1	3 – poles
53-944921-021				4 – poles
53-944921-031	RAB 00	1	1	
53-944921-041	RAB 1; RAB 2	1	1	
53-944921-051	RAB 3	1	1	



Handles

Handle for mounting on doors with IP65, ON/OFF position marking, designed for locking by up to three padlocks in OFF („0”) position, door interlock with release mechanism for opening in position I/ON, RA../R, RAB../R - handle mounted on shaft

Article	Colour	Handle length [mm]	For shaft with side length of [mm]	For use with switch of type	Set (pcs.)
H1	black	0	6	RA 100	1
H2	yellow-red			RAB 000	
OHB 95J10	black	95	10	RA 160/250	1
OHY 95J10	yellow-red			RAB 00	
OHB 125J12	black	125	12	RA 400/630	1
OHY 125J12	yellow-red			RAB 1/2	
OHB 145J12	black	145	12	RAB 3	1
OHY 145J12	yellow-red				
OHB 175J12	black	175	12	RA 1250	1
OHY 175J12	yellow-red				



H2



OHB

Shafts

Shafts of various length for switch disconnectors mounted in distribution boards.

Article No.	Shaft size [mm]	Length [mm]	For use with switch of type	Set (pcs.)
51-943952-011	∅8	100	RA 100 RAB 000	1
51-943952-021		200		
51-943952-031		400		
51-943952-041		600		
51-944280-011	∅10	100	RA 160/250 RAB 00	1
51-944280-021		200		
51-944280-031		400		
51-944280-041		600		
51-943953-011	∅12	100	RA 400/630/1250 RAB 1/2/3	1
51-943953-021		200		
51-943953-041		400		
51-943953-031		600		



Extension shafts for use with coupling mechanism for change-over switch disconnectors:
 - handle mounted on shaft - shaft with side length of 10 mm with shaft link
 - handle mounted on distribution board's door - shaft with side length of 12 mm with shaft link

Shaft links

For fixing extension shaft to switch disconnector's shaft

Article No.	Shaft size [mm]	For use with switch of type	Set (pcs.)
53-944917-041	∅6	RA 100, RAB 000	1
53-944917-051	∅8/6	RA 100, RAB 000	1
53-944917-011	∅8	RA 100, RAB 000	1
53-944917-021	∅10	RA 160/250, RAB 00	1
53-944917-031	∅12	RA 400/630/1250, RAB 1/2/3	1



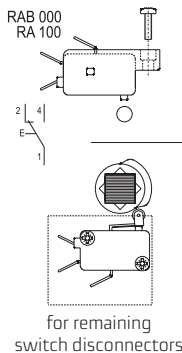

Extension shafts with shaft links

Article No.	Shaft size [mm]	Length	For use with switch of type	Set (pcs.)
63-946239-011	∅8	100	RA 100 RAB 000	1
63-946239-021		200		1
63-946239-031		400		1
63-946239-041		600		1
63-946240-011	∅10	100	RA 160/250 RAB 00	1
63-946240-021		200		1
63-946240-031		400		1
63-946240-041		600		1
63-946241-011	∅12	100	RA 400/630/1250 RAB 1/2/3	1
63-946241-021		200		1
63-946241-041		400		1
63-946241-031		600		1

Terminal shrouds

Article No.	For use with switch of type	Number of shrouds mounted on switch	Number of shrouds in package
51-839842-011	RA 100, RAB 000	2	1
51-838546-011	RA 160/250, RAB 00	2	1
51-839843-011	RA 400/630, RAB 1/2/3	6 (8)*	1

*for 3-pole switch disconnectors - 6 pcs., for 3-pole switch disconnectors with N-bar - 8 pcs.

Support element for mounting on support structure

Article No.	For use with switch of type	Number of pcs. in package (set)
On request	RAB 00, RA 160, RA 250	1
On request	RA 400, RA 630, RAB 1, RAB 2	1

Coupling mechanism for change-over switch disconnectors

Three positions: I-O-II. Mounted on shafts of switch disconnectors

Article No.	Handle mounted on shaft	
	For use with switch of type	Number of pcs. in package (set)
63-839949-011	RA 160/250	1
63-839972-011	RA 400/630	1
63-930893-011	RA 1250	1

Handle OHB mounted in distribution board

Article No.	For use with switch of type	Number of pcs. in package (set)
63-839949-021	RA 160/250	1
63-839972-021	RA 400/630	1
63-930893-021	RA 1250	1

Auxiliary contacts

For signalling of position of switch disconnectors contacts (ON/OFF).

Article No.	Auxiliary switch parameters	For use with switch of type	Number of pcs. in package	Additional information
53-944915-011	AC - 11 U _e 220 V~ I _e 1 A DC - 13 U _e 220 V~ I _e 0,25 A	RA 100 RAB 000	1	one switch
53-944916-011	AC - 11 U _e 220 V~ I _e 1 A DC - 13 U _e 220 V~ I _e 0,25 A	RA 160/250 RAB 00	1	one switch
53-944916-031		RA 400/630 RAB 1/2/3		
53-944916-021	AC - 11 U _e 220 V~ I _e 1 A DC - 13 U _e 220 V~ I _e 0,25 A	RA 160/250 RAB 00	1	two switches
53-944916-041		RA 400/630 RAB 1/2/3		