



Water & Heat Metering

2024/2025 Product Catalogue



About us

Polish tradition and high technologies

Apator Powogaz S.A. is an element of Apator S.A., our corporate group that involves the largest Polish manufacturers of metering instruments and systems for utilities. At Apator Powogaz S.A. we operate in all utility sectors by providing metering solutions for water, heat, natural gas, and electricity. We also implement advanced IT projects by developing the latest systems of network asset management for the utilities, telecoms, public administrations and local government markets.

Apator Powogaz S.A. means growth by innovation, which also means we maintain our legacy and nearly 100 years of history. By applying our experience, quality and professionalism in the design and development of instruments, we consistently build our strong position on the global markets. The production and design engineering facilities are located in Poland, the Czech Republic, and Denmark. Thanks to this we can provide a broad look at the actual needs of the market.

Our product range here at Apator Powogaz S.A. includes water meters as the core element of our production operations, as well as heat meters and heating cost allocators. We always follow the latest trends in technology, with our range of solutions expanding to include services in AMR, utility billing, and water and heat distribution management. Our products are being sold not just in Poland, but in Europe and beyond. They have become increasingly popular in the Middle East, the Far East, Asia, Africa, as well as with our business partners in the Americas.

In stepping up to the increasing demands of customers around the globe, we continue to develop our products and improve the quality of our services as a part of a consistent strategy of leadership in the industry.

Structure of the Apator Group:

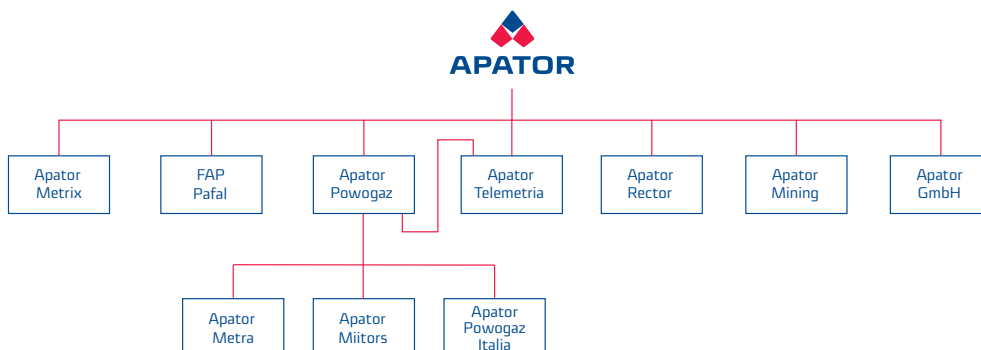

CONTENTS

Water metering

05	Ultrasonic water meters	05
	UL Ultrimis ultrasonic water meters	05
06	Vane-wheel water meters	06
	JS Smart D+ single-jet dry water meters	06
	JS Smart C+ single-jet dry water meters	07
	JS Smart+ single-jet dry water meters	08
	JS-NK single-jet dry water meters	09
	JS Master D+ single-jet dry water meters	10
	JS Master C+ single-jet dry water meters	11
	JS Master+ single-jet dry water meters	12
13	Volumetric water meters	13
	SV-RTK volumetric water meters	13
14	Vane-wheel water meters	14
	JS Impero single-jet dry water meters	14
15	Propeller water meters	15
	MWN Nubis horizontal rotor axis water meters	15
	MK chamber mount vertical rotor axis water meters	17
18	Special use water meters	18
	Fire hydrant water meters	18
	Spring-action valve coupled water meters	19
21	Flow meters	21
	WI irrigation flow meters	21

Heat metering

22	Heat metering	22
	ELF2 complete heat meters	24
	FAUN heat meter calculators	25
27	Heat meter flow sensors	26
	JS90-NC / JS130-NC single-jet dry flow sensors	26
	MWN130-NC propeller flow sensors	27
28	Heat meter temperature sensors	28
	TOP 1068 wired resistive temperature sensors	28
	TOPE 41, TOPGN 12/C & TOP 146.1 temperature sensors	29
30	Heat cost allocator	30
	E-ITN 30.51 i E-ITN40	30

AMR (automatic meter reading) systems

32	AMR (automatic meter reading) systems	32
	RF AMR	33
	Stationary AMR system	36
	RF AMR system devices	36
	RF AMR water meter add-on modules	41
	Wired AMR system	46
	Wired AMR system software	46
	Wired AMR system devices	47
	Wired AMR system water meter add-on modules	47
	SPIDAP Software - comprehensive solutions from installation to billing and more	50

Complementary range

55	Complementary range	55
	Water and heat meter accessories	56

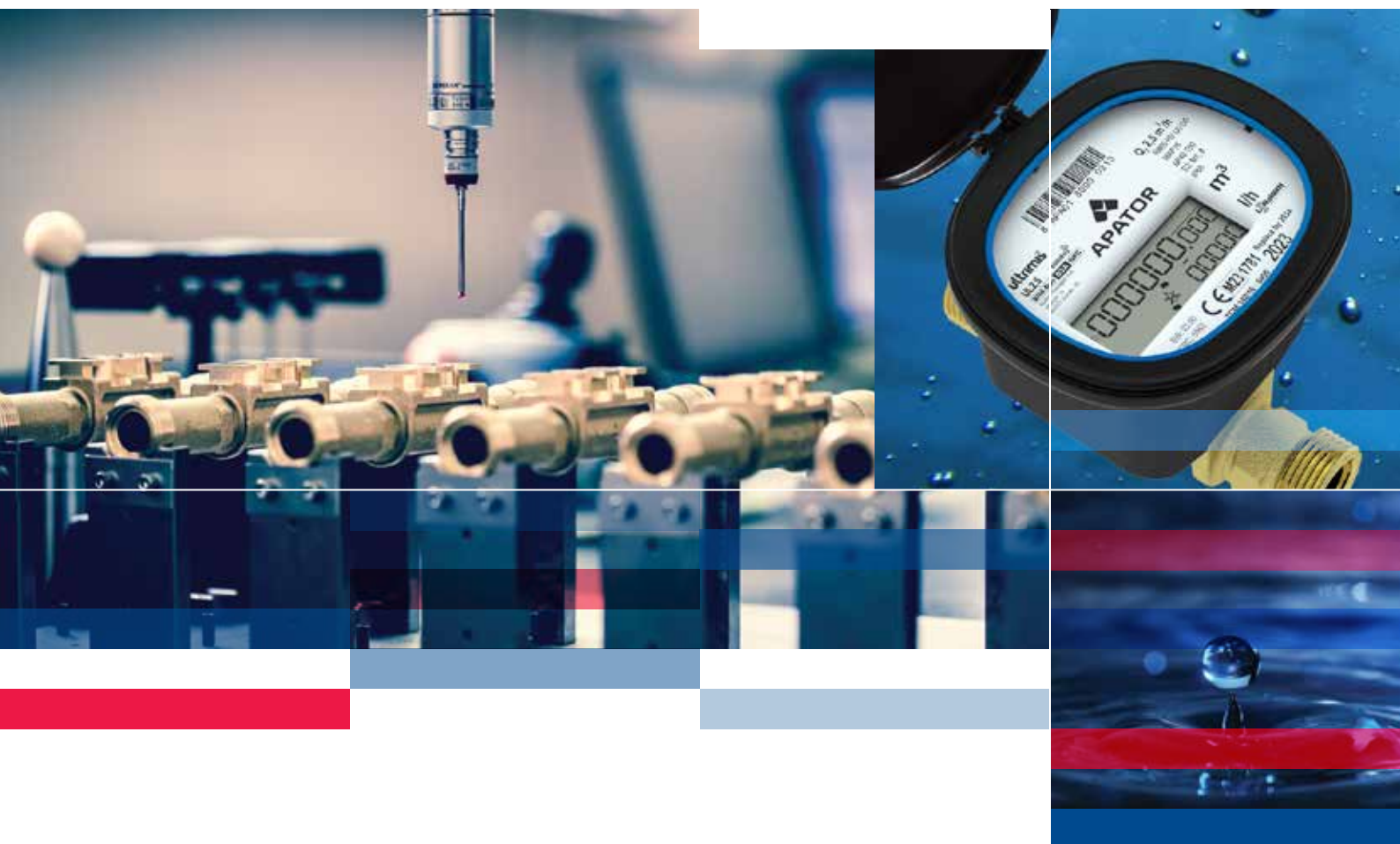

Water metering

UL ULTRIMIS

Ultrasonic water meters (DN15-50)



Application

Measurement of water flow and volumes up to 50°C or up to 70°C for hot water, in full-flow rated, closed-loop systems, MAP 16 bar, where the application requires the precision metering of water consumption. The water meter is a smart device that supports the latest connectivity solutions, like NFC, WM-Bus and LoRaWAN. Complete with an electronic display (IP68), the water meter can be installed in any orientation (**H, V and at an intermediate angle**) and requires no straight piping upstream or downstream of the connection ports, making it an UODO piping instrument.



UL ULTRIMIS

Measurement range (MID):

- Cold and hot water **R250***, **R400**, **R500** or **R800**



Table 1. Basic technical data

Type		Q ₃ (m ³ /h)	DN (mm)	Length (mm)	Connection ends	Net weight (kg)
Cold water meters – brass body						
UL 2,5 Ultrimis	R800 max	2.5	15	80; 110; 115; 165	G ³ / ₄ G ⁷ / ₈ -> G ³ / ₄ ***	0.48 to 0.60
UL 4 Ultrimis	R800 max	4	20	105; 115; 130; 190	G1	0.61 to 0.77
UL 6,3 Ultrimis	R800 max	6.3	25	165; 260	G1 ¹ / ₄	1.05; 1.39
UL 10 Ultrimis	R800 max	10	32	260	G1 ¹ / ₂	1.68
UL 16 Ultrimis	R800 max	16	40	300	G2	2.15
UL 25 Ultrimis	R500 max	25	50	200; 270; 300	G2 ¹ / ₂ or flanged**	6.29; 6.75; 6.95
Cold water meters – composite body						
UL 2,5-01 Ultrimis	R800 max	2.5	15	80; 110	G ³ / ₄	0.29; 0.31
UL 4-01 Ultrimis	R800 max	4	20	105; 130	G1	0.33; 0.34
Hot water meters – brass or composite body						
UL 2,5 Ultrimis	R800 max	2.5	15	80; 100; 115; 165	³ / ₄ " ; ⁷ / ₈ " -> ³ / ₄ "***	0.48 to 0.60
UL 4 Ultrimis	R800 max	4	20	105; 115; 130; 190	G1	0.61 to 0.77

* R250 as standard*

** Connection flange bolt hole pattern:

- Standard: PN-EN 1092-2 (PN10), DIN 2532, DIN2501 (PN10)
- Special: PN-EN 1092-2 (PN16) (available on request)

*** Thread size ⁷/₈" -> ³/₄" available for 115 mm long units only

Product features

- Measurement based on a unique and patented ultrasonic beam path through the measurement chamber: W-Sonic Technology
- No moving components in the measurement chamber
- Immune to EM fields
- IP68 as standard
- Resistant to hydrodynamic impact
- Requires no strainers or check valves
- High measurement stability, insensitive to any metering system contamination
- Measurement range up to R800 in every operating orientation (H, V and at an intermediate angle)
- Starting flow from 0.75 l/h for DN15
- Very low pressure loss
- Maximum design battery life of 16 years (depending on the configuration and ambient conditions)
- Various body materials available: brass or composite
- Hygiene standard compliant: including DVGW, WRAS, and ACS
- WELMEC 7.2 Ed. 5 compliant

JS SMART D+

Single-jet vane-wheel dry water meters (DN15-20)

Application

Measurement of water flow and volumes up to 50°C and up to 90°C for hot water, in full-flow rated, closed-loop systems, MAP 16 bar (PN16). For installation in horizontal piping with the counter pointing upwards (H↑) or sideways (H→) and in vertical piping with the counter pointing sideways (V). The standard Smart D+ water meters feature low-profile 8-barrel counters (IP65), brass bodies, and pre-equipment for AMR (automatic meter reading) connectivity via communication modules.

Measurement range (MID):

- Cold water: **R160; R200** – (H↑); **R80 - V, (H→)**
- Hot water: **R160** – (H↑); **R80 - V, (H→)**

Table 2. Basic technical data

Type		Q ₃ (m ³ /h)	DN (mm)	Length* (mm)	Connection ends	Net weight (kg)
Cold water meters						
JS 1,6-05 Smart D+	R160	1.6	15	110	G 3/4	0.463
JS 1,6-07 Smart D+	R160	1.6	15	110	G 3/4	0.463
JS 2,5-05 Smart D+	R200	2.5	15	110	G 3/4; G 7/8	0.458
JS 2,5-07 Smart D+	R200	2.5	15	110	G 3/4; G 7/8	0.458
JS 2,5-G1-05 Smart D+	R200	2.5	20	130	G1	0.589
JS 2,5-G1-07 Smart D+	R200	2.5	20	130	G1	0.589
JS 4-05 Smart D+	R200	4	20	130	G1	0.552
JS 4-07 Smart D+	R200	4	20	130	G1	0.552
Hot water meters						
JS90 1,6-05 Smart D+	R160	1.6	15	110	G 3/4	0.463
JS90 1,6-07 Smart D+	R160	1.6	15	110	G 3/4	0.463
JS90 2,5-05 Smart D+	R160	2.5	15	110	G 3/4; G 7/8	0.458
JS90 2,5-07 Smart D+	R160	2.5	15	110	G 3/4; G 7/8	0.458
JS90 2,5-G1-05 Smart D+	R160	2.5	20	130	G1	0.589
JS90 2,5-G1-07 Smart D+	R160	2.5	20	130	G1	0.589
JS90 4-05 Smart D+	R160	4	20	130	G1	0.552
JS90 4-07 Smart D+	R160	4	20	130	G1	0.552

Water meter versions:

-05 – 8-barrel counter, brass body, communication module installation ready, version with a snap ring and a cover

-07 – 8-barrel counter, brass body, communication module installation ready, version with a snap ring, without a cover

Available on special request:

-TI/IR - with counter pointer in an optical reading version

* Custom designs of body length for JS 2,5 DN15 and DN20:

L = 115 mm 3/4" > 3/4";

L = 115 mm 1" > 1";

custom thread sizes, e.g. L = 115 mm 7/8" > 3/4"

Product features

- High measuring sensitivity R-rating
- Revised water meter counter guard with improved resistance to tampering
- Reliable readings in compliance with MID requirements
- Pre-equipped for optional data communication modules
- Easy counter reading
- Fogging-resistant hermetical counter (by increased sealing)
- Counter mechanism rotation lock of 358°
- Frost-damage protection
- Double-sided rotor bearings
- Water meter outlet end pre-equipped for a check valve



JS-05 SMART D+

JS-07 SMART D+



JS SMART C+

Single-jet vane-wheel dry water meters (DN15-20)

Application

Measurement of water flow and volumes up to 50°C in full-flow rated, closed-loop systems, MAP 16 bar (PN16). For installation in horizontal piping with the counter pointing upwards (**H↑**) or sideways (**H→**) and in vertical piping with the counter pointing sideways (**V**). The standard Smart C+ water meters feature 8-barrel counters (IP65), SN+ anti-tamper magnetic protection, brass bodies, and pre-equipped for AMR (automatic meter reading) connectivity via communication modules.

JS-03 SMART C+



JS-02 SMART C+

Measurement range (MID):

- Cold water: **R160 - (H↑); R63 - V, (H→)**



Table 3. Basic technical data

Type		Q ₃ (m ³ /h)	DN (mm)	Length* (mm)	Connection ends	Net weight (kg)
Cold water meters						
JS 1,6-02 Smart C+	R160	1.6	15	110	G3/4	0.50
JS 1,6-03 Smart C+	R160	1.6	15	110	G3/4	0.22
JS 2,5-02 Smart C+	R160	2.5	15	110	G3/4	0.50
JS 2,5-03 Smart C+	R160	2.5	15	110	G3/4	0.21
JS 2,5-G1-02 Smart C+	R160	2.5	20	130	G1	0.60
JS 4-02 Smart C+	R160	4	20	130	G1	0.60

Water meter versions:

- **02** – 8-barrel counter, brass body, communication module installation ready
- **03** – 8-barrel counter, composite body, communication module installation ready

Available on request:

- **IP68** – counter ingress protection (IP) rating
- **TI/IR** – with pointer for optical reading or inductive reading

* Custom designs of body length for JS 2,5 DN15 and DN20:

L = 115 mm 3/4" > 3/4"

L = 115 mm 1" > 1"

custom thread sizes, e.g. L = 115 mm 7/8" > 3/4"

Product features

- SN+: external EM fields immunity exceeds the standard requirements
- Pre-equipped for optional data communication modules
- Reliable readings in compliance with MID requirements
- Easy counter reading
- Fogging-resistant hermetical counter (by increased sealing)
- Counter mechanism rotation lock of 358°
- External mechanical tamper protection
- Frost-damage protection
- Double-sided rotor bearings
- Water meter outlet end pre-equipped for a check valve

JS SMART +

Single-jet vane-wheel dry water meters (DN15-20)

Application

Measurement of water flow and volumes up to 50°C and up to 90°C for hot water, in full-flow rated, closed-loop systems, MAP 16 bar (PN16). For installation in horizontal piping with the counter pointing upwards (H↑) or sideways (H→) and in vertical piping with the counter pointing sideways (V). The standard Smart+ water meters feature 8-barrel counters (IP65), SN+ anti-tamper magnetic protection, brass bodies, and pre-equipment for AMR (automatic meter reading) connectivity via communication modules.

Measurement range (MID):

- Cold water: **R100** - (H↑); **R50** - V, (H→)
- Hot water: **R100** - (H↑); **R50** - V, (H→)

Table 4. Basic technical data

Type		Q ₃ (m ³ /h)	DN (mm)	Length* (mm)	Connection ends	Net weight (kg)
Cold water meters						
JS 1,6-02 Smart+	R100	1.6	15	110	G ³ / ₄	0.43
JS 1,6-03 Smart+	R100	1.6	15	110	G ³ / ₄	0.25
JS 2,5-02 Smart+	R100	2.5	15	110	G ³ / ₄	0.43
JS 2,5-03 Smart+	R100	2.5	15	110	G ³ / ₄	0.25
JS 2,5-G1-02 Smart+	R100	2.5	20	130	G1	0.57
JS 4-02 Smart+	R100	4	20	130	G1	0.53
Hot water meters						
JS90 1,6-02 Smart+	R100	1.6	15	110	G ³ / ₄	0.43
JS90 1,6-03 Smart+	R100	1.6	15	110	G ³ / ₄	0.25
JS90 2,5-02 Smart+	R100	2.5	15	110	G ³ / ₄	0.43
JS90 2,5-03 Smart+	R100	2.5	15	110	G ³ / ₄	0.25
JS90 2,5-G1-02 Smart+	R100	2.5	20	130	G1	0.57
JS90 4-02 Smart+	R100	4	20	130	G1	0.53

Water meter versions:

- 02 – 8-barrel counter, brass body, communication module installation ready
- 03 – 8-barrel counter, composite body (available in JS 1,6 and JS 2,5 with 110 mm length, R100 for cold water and hot water)

Available on request:

- IP68 – counter ingress protection (IP) rating
- TI/IR – with a pointer for optical or induction reading
- 02-S – hardened bearing version (for hot water circulation systems)

* Custom designs of body length for JS 2,5 DN15 and DN20:

- L = 80 mm ³/₄" > ³/₄";
- L = 115 mm ³/₄" > ³/₄";
- L = 115 mm 1" > 1";
- custom thread sizes, e.g. L = 115 mm ⁷/₈" > ³/₄"

JS-03 SMART+

JS-02 SMART+



JS90-03 SMART+

JS90-02 SMART+



Product features

- SN+: strong external EM fields immunity exceeds the standard requirements
- Pre-equipped for optional data communication modules
- Reliable readings in compliance with MID requirements
- Easy counter reading
- Fogging-resistant hermetical counter (by increased sealing)
- Counter mechanism rotation lock of 358°
- External mechanical tamper protection
- Frost-damage protection
- Water meter outlet end pre-equipped for a check valve
- Double-sided rotor bearings

JS-NK

Single-jet vane-wheel dry water meters (DN15-20)

Application

Measurement of water flow and volumes up to 50°C and up to 90°C for hot water, in full-flow rated, closed-loop systems, MAP 16 bar (PN16). For installation in horizontal piping with the counter pointing upwards (**H↑**) or sideways (**H→**) and in vertical piping with the counter pointing sideways (**V**). Complete with pulse modules (JS-NK). The standard versions feature 5-barrel counters (IP65), anti-tamper magnetic protection, and brass bodies. The water meters can support AMR (automatic meter reading) connectivity.



JS90-NK

JS-NK



Measurement range (MID):

- Cold water: **R100 - (H↑); R50 - V, (H→)**
- Hot water: **R80 - (H↑); R40 - V, (H→)**

Table 5. Basic technical data

Type	Q ₃ (m ³ /h)	DN (mm)	Length (mm)	Connection ends	Net weight (kg)	NK pulse value (dm ³ /pulse)		
						Standard	On request	
Cold water meters								
JS 1,6-NK	R100	1.6	15	110	G ³ / ₄	0.65	10	0.25; 1; 2.5
JS 2,5-NK	R100	2.5	15	110*	G ³ / ₄	0.65		
JS 2,5-G1-NK	R100	2.5	20	130	G1	0.75		
JS 4-NK	R100	4	20	130	G1	0.75		
Hot water meters								
JS90 1,6-NK	R80	1.6	15	110	G ³ / ₄	0.65	10	0.25; 1; 2.5
JS90 2,5-NK	R80	2.5	15	110*	G ³ / ₄	0.65		
JS90 2,5-G1-NK	R80	2.5	20	130	G1	0.75		
JS90 4-NK	R80	4	20	130	G1	0.75		

Water meter versions:

-NK – water meter with a reed relay transmitter, standard wiring length: 2 lin.m. for remote volume reading output

Special water meter versions available on request:

-S – bearing version (for hot water circulation systems)

* 115 mm or 80 mm long versions (available in JS 2,5 and JS90 2,5 with brass bodies)

IP68-rated water meter version

Product features

- Easy counter reading
- Fogging-resistant hermetical counter (by increased sealing)
- Counter mechanism rotation lock of 358°
- External mechanical tamper protection
- Frost-damage protection
- Double-sided rotor bearings
- Water meter outlet end pre-equipped for a check valve

JS MASTER D+

Single-jet vane-wheel dry water meters (DN25-40)

Application

Cold water supply systems of up to 50°C (with IP68 or IP65-rated water meters) in multifamily housing, industrial facilities, public facilities, and metering stations. The maximum operating pressure (MAP) is 16 bar. The water meter is designed for installation in a horizontal orientation with the counter pointing upwards (**H↑**) or sideways (**H→**), and in vertical piping with the counter pointing sideways (**V↑**).

The JS Master D+ water meters are available in the standard version with a 5-barrel counter (IP65), a brass body with anti-tamper magnetic protection and pre-equipment for RF, pulse and M-Bus communication modules. A special version of the water meter is available with the NK transmitter module.



Measurement range (MID):

- Cold water: **R200 - H↑; R63 - V, H→**



Table 6. Basic technical data

Type	Q ₃ (m ³ /h)	DN (mm)	Length (mm)	Connection ends	Net weight (kg)	NK pulse value (dm ³ /pulse)		
						Standard	On request	
Cold water meters								
JS 6,3-02 Master D+	R200	6.3	25	165/260	G1¼	2	-	-
JS 10-02 Master D+	R200	10	32	260	G1½	2.2	-	-
JS 16-02 Master D+	R200	16	40	300	G2	2.5	-	-
JS 6,3-07 Master D+	R200	6.3	25	165/260	G1¼	2	-	-
JS 10-07 Master D+	R200	10	32	260	G1½	2.2	-	-
JS 16-07 Master D+	R200	16	40	300	G2	2.5	-	-
JS 6,3-NK Master D+	R200	6.3	25	165/260	G1¼	2	10 (standard pulse rate); 100 (standard pulse rate); 10	100 (standard pulse rate); 10
JS 10-NK Master D+	R200	10	32	260	G1½	2.2	100	10
JS 16-NK Master D+	R200	16	40	300	G2	2.5	100	10

Water meter versions:

-02 - counting mechanism in IP65 protection, suitable for communication modules for remote TI/IR reading

-07 - IP68-rated counter mechanism sealed with mineral glass enclosure with a copper guard, the water meter supports readout with induction communication modules (TI)

-NK - with a reed relay transmitter, standard wiring length: 2 lin.m. for remote volume reading output

Product features

- Pre-equipped for optional data communication modules (not applicable for the NK version)
- Easy counter reading
- Counter mechanism rotation lock of 358°
- External mechanical tamper protection
- Double-sided rotor bearings

JS MASTER C+

Single-jet vane-wheel dry water meters (DN25-40)

Application

Measurement of water flow and volumes up to 30°C or 50°C in full-flow rated, closed-loop systems, MAP 16 bar (PN16). For installation in horizontal piping with the counter pointing upwards (**H**↑) or sideways (**H**→) and in vertical piping with the counter pointing sideways (**V**↑).

The JS Master C+ water meters are available in the standard version with a 5-barrel counter (IP65), a brass body with anti-tamper magnetic protection and pre-equipment for communication modules. A special version of the water meter is available with the NK transmitter module. The water meters are designed for operation in AMR systems.



Measurement range (MID):

- Cold water: **R160 - H**↑; **R63 - V,H** →

Table 7. Basic technical data

Type	Q ₃ (m ³ /h)	DN (mm)	Length (mm)	Connection ends	Net weight (kg)	NK pulse value (dm ³ /pulse)		
						Standard	On request	
Cold water meters								
JS 6,3-02 Master C+	R160	6.3	25	165/260	G1¼	2	-	-
JS 10-02 Master C+	R160	10	32	260	G1½	2.2	-	-
JS 16-02 Master C+	R160	16	40	300	G2	2.5	-	-
JS 6,3-07 Master C+	R160	6.3	25	165/260	G1¼	2	-	-
JS 10-07 Master C+	R160	10	32	260	G1½	2.2	-	-
JS 16-07 Master C+	R160	16	40	300	G2	2.5	-	-
JS 6,3-NK Master C+	R160	6.3	25	165/260	G1¼	2	10 (standard pulse rate); 100	100 (standard pulse rate); 10
JS 10-NK Master C+	R160	10	32	260	G1½	2.2	100	10
JS 16-NK Master C+	R160	16	40	300	G2	2.5	100	10

Water meter versions:

- 02 - counting mechanism in IP65 protection, suitable for communication modules for remote TI/IR reading
- 07 - IP68-rated counter mechanism sealed with mineral glass enclosure with a copper guard, the water meter supports readout with induction communication modules (TI)
- NK - water meter with a reed relay transmitter, standard wiring length: 2 lin.m. for remote volume reading output

Product features

- Pre-equipped for optional data communication modules (not applicable for the NK version)
- Easy counter reading
- Available with an IP68-rated hermetic counter version
- Counter mechanism rotation lock of 358°
- External mechanical tamper protection
- Double-sided rotor bearings

JS MASTER+

Single-jet vane-wheel dry water meters (DN25-40)

Application

Measurement of water flow and volumes up to 30°C, 50°C or 130°C hot water in full-flow rated, closed-loop systems, MAP 16 bar (PN16). For installation in horizontal piping with the counter pointing upwards (H↑) or sideways (H→) and in vertical piping with the counter pointing sideways (V↗).

The JS Master+ water meters are available in the standard version with a 5-barrel counter (IP65), a brass body with anti-tamper magnetic protection and pre-equipment for communication modules. A special version of the water meter is available with the NK transmitter module. The water meters are designed for operation in AMR systems.

JS-07 MASTER+ (IP68)



JS-02 MASTER+ (IP65)

JS130-NK MASTER+ (IP65)



Measurement range (MID):

- Cold water: **R100 - H↑; R50 - V, H→**
- Hot water: **R100 - H↑; R40 - V, H→**

Table 8. Basic technical data

Type	Q ₃ (m ³ /h)	DN (mm)	Length (mm)	Connection ends	Net weight (kg)	NK pulse value (dm ³ /pulse)		
						Standard	On request	
Cold water meters								
JS 6,3-02 Master+	R100	6.3	25	165/260	G1¼	2.0	-	-
JS 10-02 Master+	R100	10	32	260	G1½	2.2	-	-
JS 16-02 Master+	R100	16	40	300	G2	2.5	-	-
JS 6,3-07 Master+	R100	6.3	25	165/260	G1¼	2	-	-
JS 10-07 Master+	R100	10	32	260	G1½	2.5	-	-
JS 16-07 Master+	R100	16	40	300	G2	2.5	-	-
JS 6,3-NK Master+	R100	6.3	25	165/260	G1¼	2	10	100
JS 10-NK Master+	R100	10	32	260	G1½	2.5	100	10
JS 16-NK Master+	R100	16	40	300	G2	2.5	100	10
Hot water meters								
JS130 6,3-02 Master+	R100	6.3	25	165/260	G1¼	2.0	-	-
JS130 10-02 Master+	R100	10	32	260	G1½	2.2	-	-
JS130 16-02 Master+	R100	16	40	300	G2	2.5	-	-
JS130 6,3-NK Master+	R100	6.3	25	165/260	G1¼	2	100	100
JS130 10-NK Master+	R100	10	32	260	G1½	2.5	100	10
JS130 16-NK Master+	R100	16	40	300	G2	2.5	100	10

Water meter versions:

-02 - counting mechanism in IP65 protection, suitable for communication modules for TI/IR reading

-07 - IP68-rated counter mechanism sealed with mineral glass enclosure with a copper guard, the water meter supports readout with induction communication modules (TI)

-NK - water meter with a reed relay transmitter, standard wiring length: 2 lin.m. for remote volume reading output

Product features

- Pre-equipped for optional data communication modules (not applicable for the NK version)
- Easy counter reading
- Available with an IP68-rated hermetic counter version
- Counter mechanism rotation lock of 358°
- External mechanical tamper protection
- Double-sided rotor bearings

SV-RTK

Cold water volumetric dry water meters (DN15-40)

Application

Measurement of water flow and volumes up to 30°C or 50°C in full-flow rated, closed-loop systems, MAP 16 bar (PN16). For installation in horizontal, vertical and sloping piping in **any orientation** with full metrological performance. The standard water meter versions feature 8-barrel counters (IP65) and brass bodies. The water meters are designed for operation in AMR systems via communication modules



SV-RTK

Measurement range (MID):

- Cold water: **R200**



Table 9. Basic technical data

Type		Q ₃ (m ³ /h)	DN (mm)	Length (mm)	Connection ends	Net weight (kg)
Cold water meters						
SV-RTK 2,5	R200	2.5	15	110	G ³ / ₄	1.0
	R200	2.5	20	165	G1	1.4
SV-RTK 4,0	R200	4.0	20	190	G1	1.3
SV-RTK 6,3	R200	6.3	25	260	G1 ¹ / ₄	3.2
SV-RTK 10	R200	10	32	260	G1 ¹ / ₂	4.6
SV-RTK 16	R200	16	40	300	G2	6.9

Product features

- Pre-equipped for optional data communication modules
- Extremely high measurement accuracy even at the lowest water flow rates
- Steady metrological parameters insensitive to the installation orientation
- Extremely low starting flow: from 1.5 dm³/h in the DN15 size
- External mechanical tamper protection
- Redundant protection against the ingress of contaminants to the metering unit
- Water meter outlet end pre-equipped for an optional check valve

JS IMPERO

Single-jet vane-wheel dry water meters (DN50-100)

Application

Precision metering of high cold water consumption of up to 50°C in full-flow rated, closed-loop systems, MAP 16 bar (PN16). For installation in horizontal piping with the counter upward (**H**). The standard versions of type JS and JS-NKOP feature 6-barrel counters and powder-coated cast-iron bodies. The water meters with communication modules (IP65 and IP68-rated) and the special version with the NK transmitter module (IP65-rated) are designed for operation in AMR systems.



JS IMPERO; JS-NKOP IMPERO

Measurement range (MID):

- Cold water: **R315 - H**



Table 10. Basic technical data

Type	Q ₃ (m ³ /h)	DN (mm)	Length (mm)	Connection ends	Net weight (kg)	Pulse value (dm ³ /pulse)					
						NK					
						Standard	On request	NO			
Cold water meters											
JS 50	25	50	270 / 300*	flanged	11.8	-	-	-			
JS 65	40	65	300		16.6						
JS 80	63	80	300 / 350*		20						
JS 100	100	100	360 / 350*		23.5						
JS 50-08	R315	25	50		270 / 300*				11.8		
JS 65-08		40	65		300				16.6		
JS 80-08		63	80		300 / 350*				20		
JS 100-08		100	100		360 / 350*				23.5		
JS 50-XX	25	50	270 / 300*		11.8				100	10	1
JS 65-XX	40	65	300		16.6						
JS 80-XX	63	80	300 / 350*		20						
JS 100-XX	100	100	360 / 350*		23.5						

Water meter versions:
-08 – IP68-rated counter mechanism and cover, the water meter supports readout with induction communication modules only (TI)
-XX notation:
 - **NKP** – water meter counter (IP65) pre-equipped for installation of NK transmitter
 - **NKOP** – water meter counter (IP65) pre-equipped for installation of NK and/or NO transmitter modules

Connection flange bolt hole pattern:
 - Standard: PN-EN 1092-2 (PN10), DIN 2532, DIN2501 (PN10)
 - Special: PN-EN 1092-2 (PN16) - available on request
 - Extra: ANSI B16.5 Class 150 (DN40-300) - available on request

Standard total length according to DIN 19625
 * Total length according to ISO4064 - on request

Product features

- Pre-equipped for optional data communication modules (not applicable for the JS-NKOP version)
- Wide measurement range
- Low starting flow
- Double-sided rotor bearings
- Removable measuring insert
- Easy counter reading
- Counter mechanism rotation lock of 358°
- Reliable readings
- Available with an IP68-rated hermetic counter version
- Optional version of the body with a pressure gauge connection port

MWN NUBIS

Horizontal rotor axis propeller water meters (Woltman) (DN40-400)

Application

Measurement of high cold water consumption up to 30°C or 50°C and hot water up to 130°C, MAP 16 bar (PN16). For installation in horizontal piping with the counter upward (**H**), in vertical piping with the counter sideways (**V**). The standard versions of type MWN feature 6-barrel counters and powder-coated cast-iron bodies. The water meters with communication modules (IP65 and IP68-rated) and the special version with the NK transmitter module (IP65-rated) are designed for operation in AMR systems.

Measurement range (MID):

MWN / MWN130

- Cold water: **R100 to 200 - H, V**
- Hot water: **R25 to 40 - H, V**

MWN-G / MWN130-G

- Cold water: **R100 - H, V**
- Hot water: **R40 - H, V**



Table 11. Basic technical data

Type	Q ₃ (m ³ /h)	DN (mm)	Length (mm)	Connection ends	Net weight (kg)	Pulse value (dm ³ /pulse)		
						NK		
						Standard	On request	NO
Cold water meters								
MWN 40 Nubis	R100	25	40	200	7.9			
MWN 50 Nubis	R100	40	50	200	9.9			
MWN 50-G Nubis	R100	40	50	200	5.4			
MWN 65 Nubis	R125	63	65	200	10.6			
MWN 80 Nubis	R160	100	80	225	13.8			
MWN 100 Nubis	R200	160	100	250	13.3			
MWN 125 Nubis	R160	250	125	250	15.6			
MWN 150 Nubis	R200	400	150	300	18.1			
MWN 200 Nubis	R125	630	200	350	40.1			
MWN 250 Nubis	R100	1000	250	450	51.1			
MWN 300 Nubis	R125	1600	300	500	75.1			
MWN 400 Nubis	Class B	1000 (Qn)	400	600	103.1			
MWN 400 Nubis	Class B	1000 (Qn)	400	600	240.0			
MWN 40-XX Nubis	R100	25	40	200	8.3			
MWN 50-XX Nubis	R100	40	50	200	10.3			
MWN 50-G-XX Nubis	R100	40	50	200	5.8			
MWN 65-XX Nubis	R125	63	65	200	11	100	10	1
MWN 80-XX Nubis	R160	100	80	225	14.2			
MWN 80-XX Nubis	R160	100	80	200*	13.7			
MWN 100-XX Nubis	R200	160	100	250	16			
MWN 125-XX Nubis	R160	250	125	250	18.5			
MWN 150-XX Nubis	R200	400	150	300	40.5			
MWN 200-XX Nubis	R125	630	200	350	51.5	1000	100	10
MWN 250-XX Nubis	R100	1000	250	450	75.5			
MWN 300-XX Nubis	R125	1600	300	500	103.5	1000	-	105.2632
MWN 400-XX Nubis	Class B	1000 (Qn)	400	600	240.4	10000	1000	105.2632

Type	Q ₃ (m ³ /h)	DN (mm)	Length (mm)	Connection ends	Net weight (kg)	Pulse value (dm ³ /pulse)		
						NK		NO
						Standard	On request	
Hot water meters								
MWN130 40 Nubis	R40	25	40	200	flanged****			
MWN130 50 Nubis	R40	25	50	200				
MWN130 50-G Nubis	R40	25	50	200	G2½			
MWN130 65 Nubis	R40	40	65	200	flanged			
MWN130 80 Nubis	R40	63	80	200*				
				225				
MWN130 100 Nubis	R40	100	100	250				
MWN130 125 Nubis	R40	160	125	250				
MWN130 150 Nubis	R40	250	150	300				
MWN130 200 Nubis	R25	400	200	350				
MWN130 250 Nubis	R25	630	250	450				
MWN130 300 Nubis	R25	1000	300	500				
MWN130 40-XX Nubis	R40	25	40	200	flanged			
MWN130 50-XX Nubis	R40	25	50	200				
MWN130 50-G-XX Nubis	R40	25	50	200	G2½			
MWN130 65-XX Nubis	R40	40	65	200	flanged	100	10	
MWN130 80-XX Nubis	R40	63	80	200*				
				225				
MWN130 100-XX Nubis	R40	100	100	250				
MWN130 125-XX Nubis	R40	160	125	250	flanged			
MWN130 150-XX Nubis	R40	250	150	300				
MWN130 200-XX Nubis	R25	400	200	350		1000	10	
MWN130 250-XX Nubis	R25	630	250	450				
MWN130 300-XX Nubis	R25	1000	300	500		1000	-	

Water meter versions:

- IP68-rated counter mechanism and cover; the water meter supports readout with induction communication modules only

-XX notation:

-NKP – water meter counter pre-equipped for installation of NK transmitter modules (applies also to hot water meter versions)

-NKOP – water meter counter (IP65) pre-equipped for installation of NK and/or NO (for cold water meter versions) transmitter modules

* ISO 4064 standardised body length available on request

Connection flange bolt hole pattern:

- Standard: PN-EN 1092-2 (PN10), DIN 2532, DIN2501 (PN10)

- Special: PN-EN 1092-2 (PN16) - available on request

Product features

- Pre-equipped for optional data communication modules (not applicable to hot water meters or versions designed for the NKP and NKOP transmitter modules)
- Wide measurement range
- Low starting flow
- Removable measuring insert
- Double-sided rotor bearings
- Easy counter reading
- Available with an IP68-rated hermetic counter version
- Counter mechanism rotation lock of 358°
- Reliable readings

MK

Chamber mount vertical rotor axis (Woltman) water meters (DN50-150)

Application

Measurement of high cold water consumption up to 30°C, MAP 16 bar (PN16). For installation at water drawing locations (i.e. deep wells). The water meter is installed at the piping direction transition from the vertical to the horizontal, and with the counter upward. The water meters with communication modules (IP65 and IP68-rated) and the special version with the NK transmitter module (IP65-rated) are designed for operation in AMR systems.



MK-01 (IP65)

MK-08 (IP68)

Measurement range (MID):

- Cold water: **R63**



Table 12. Basic technical data

Type	Q ₃ (m ³ /h)	DN (mm)	Length* (mm)	Connection ends	Net weight (kg)	Pulse value (dm ³ /pulse)			
						Standard	On request	NO	
Cold water meters									
MK 50-01	R63	25	50	150	flanged	14	-	-	-
MK 80-01		63	80	180		18			
MK 100-01		100	100	200		24			
MK 150-01		250	150	250		45			
MK 50-08		25	50	150		14			
MK 80-08		63	80	180		18			
MK 100-08		100	100	200		24			
MK 150-08		250	150	250		45			
MK 50-01-XX	R63	25	50	150	flanged	14	100	10	1
MK 80-01-XX		63	80	180		18			
MK 100-01-XX		100	100	200		24			
MK 150-01-XX		250	150	250		45			

Water meter versions:

-01 – basic IP65 design

-08 – IP68-rated counter mechanism and cover, the water meter supports readout with induction communication modules only

-XX notation:

- **NKP** – water meter counter pre-equipped for installation of NK transmitter modules

- **NKOP** – water meter counter (IP65) pre-equipped for installation of NK and/or NO transmitter modules

* Size as measured from the inlet vertical line to the cross-sectional plane of the outlet flange

Connection flange bolt hole pattern:

- Standard: PN-EN 1092-2 (PN10), DIN 2532, DIN2501 (PN10)

- Special: PN-EN 1092-2 (PN16) - available on request

Product features

- Pre-equipped for optional data communication modules (not applicable for the NKP and NKOP versions)
- Wide measurement range
- Low starting flow
- Removable measuring insert
- Double-sided rotor bearings
- Easy counter reading
- Available with an IP68-rated hermetic counter version
- Counter mechanism rotation lock of 358°
- Reliable readings

FIRE HYDRANT WATER METERS

MH-08 | MWN50-GH | JS16-H

Vertical (MH-08) / horizontal (MWN50-GH) rotor axis propeller water meters
Single-jet vane wheel water meters (JSH)

Application

MH-08 – Instant measurement of water volume up to 30°C by quick-release connection to 80 mm underground fire hydrants, MAP 16 bar (PN16). The fire hydrant outlet requires a size 75 mm Storz quick-release coupling. The MH-08 water meter counter rated at IP68 is fogging-resistant: the counter mechanism is sealed in an IP68-rated glass and copper enclosure. The water meter is designed for operation in AMR systems via communication modules.

JS16-H and **MWN50-GH** – Instant measurement of water volume up to 30°C (JS16-H) or 50°C (MWN50-GH) by quick-release connection to DN80 and DN100 fire hydrants with size 75 mm Storz quick-release couplings, MAP 16 bar (PN16). The water meter to-fire hydrant connection is designed for the counter oriented upward. The water meters are designed for operation in AMR systems via communication modules.



Measurement range (MID):

- Cold water: **R63**
MWN50-GH, JS16-H
- Cold water: **R100-H**



Table 13. Basic technical data

Type		Q ₃ (m ³ /h)	DN (mm)	Length (mm)	Connection ends	Net weight (kg)
Cold water meters						
MH-08	R63	25	50	130*	75T hull	10
	R63	40	65	130*	75T hull	10.5
JS16-H	R100	16	40	430	75T union and 52T Storz	3.6
MWN50-GH**	R100	40	50	300	75T union and 75T Storz	5.6

* Size as measured from the inlet vertical line to the cross-sectional plane of the outlet flange

** Counter versions available on request:

- IP68 – glass and copper design version, pre-equipped for operation with an induction communication modules only

Product features

- A mobile metering solution
- Easy counter reading
- Hermetic counter
- Counter mechanism rotation lock of 358°
- Double-sided rotor bearings

MWN/JS-S

Spring-action valve coupled water meters (DN50-150)

Application

Measurement of cold water consumption up to 30°C or 50°C with wide flow rate fluctuations (from minimum to maximum values), MAP 16 bar (PN16). Recommended for installation in industrial plants, public facilities (including hospitals, schools, and hotels), and apartment buildings – especially with fire hydrant couplings. For installation in horizontal piping with the counter upward (**H**). The standard versions of the coupled water meters are available with counters (IP65). The water meters are designed for operation in AMR systems via communication modules.

MWN/JS-S (IP68)



MWN/JS-S (IP65)

Measurement range (MID):

- Cold water: **R630 to R4000 - H**

Side water meter installation

- Standard version: right-hand (looking in the direction of flow)
- On request: left-hand (looking in the direction of flow)



Table 14. Basic technical data

Type	Q ₃ (m ³ /h)	DN (mm)	Length (mm)	Connection ends	Net weight (kg)	NK pulse value (dm ³ /pulse)	
						Standard	On request
MWN / type JS side water meter – Single-jet vane-wheel dry water meter							
MWN/JS 50/4,0-S	R630	25	50	270 300*	flanged	17.5 19.4	-
MWN/JS 65/4,0-S	R1000	40	65	300		21.0	
MWN/JS 80/4,0-S	R1600	63	80	300 350*		25.0	
MWN/JS 100/4,0-S	R2500	100	100	360 350*		27.7	
MWN/JS 150/16-S	R1600	250	150	500±15		30.0	
MWN/JS 50/4-S JS R160 Smart C+ side water meter	R1000	25	50	270 300*	17.5 19.4	-	
MWN/JS 65/4-S JS R160 Smart C+ side water meter	R1600	40	65	300	21.0		
MWN/JS 80/4-S JS R160 Smart C+ side water meter	R2500	63	80	270 350*	25.0 27.7		
MWN/JS 100/4-S JS R160 Smart C+ side water meter	R4000	100	100	360 350*	30.0 30.0		
MWN/JS 150/16-S JS R160 Master C+ side water meter	R2500	250	150	500±15	75.0		
MWN/JS 50/4,0-S-NKP	R630	25	50	270 300*	18 19.9	100 / 10	10 / 0.25 1 2.5 100 250 1000
MWN/JS 65/4,0-S-NKP	R1000	40	65	300	21.5		
MWN/JS 80/4,0-S-NKP	R1600	63	80	300 350*	25.5 28.2		
MWN/JS 100/4,0-S-NKP	R2500	100	100	360 350*	30.5 30.5		
MWN/JS 150/16-S-NKP	R1600	250	150	500±15	75.5		

Water meter versions:

-NKP – water meter counter (IP65) or (IP68) pre-equipped for installation of NK transmitter modules
The IP68-rated water meters are designed for induction communication modules only

* Body length available on request

Connection flange bolt hole pattern:

- Standard: PN-EN 1092-2 (PN10), DIN 2532, DIN2501 (PN10)
- Special: PN-EN 1092-2 (PN16) - available on request

Product features

- Pre-equipped for optional data communication modules (does not apply to NKP design)
- Wide measurement range
- Low starting flow
- Double-sided rotor bearings
- Easy counter reading
- Hermetic IP68 counter available on request
- Counter mechanism rotation lock of 358°
- Reliable readings

WI

Irrigation water meters (DN40-250)

Application

The irrigation water meters are intended for the measurement of water drawn from rivers and other bodies of water, and the output of contained wastewater piping in STPs up to 50°C, MAP 16 bar (PN16). For installation in horizontal piping with the counter upward (**H**), in vertical piping (**V, H**), or in sloping piping. The standard version of the irrigation water meters features IP86-rated counters and are pre-equipped for operation in AMR systems via communication modules.

WI-08 (IP68)



Table 15. Basic technical data

Type	Q ₃ (m ³ /h)	DN (mm)	Length (mm)	Connection ends	Net weight (kg)	NK pulse value (dm ³ /pulse)	
						Standard	On request
Cold irrigation water meters							
WI 40-03-NKP	20	40	200	flanged	7.6	1000	100
WI 50-03-NKP	25	50	200		8.2		
WI 65-03-NKP	40	65	200		9.7		
WI 80-03-NKP	63	80	225		12.1		
WI 100-03-NKP	100	100	250		14.8		
WI 125-03-NKP	160	125	250		18.8		
WI 150-03-NKP	250	150	300		24.6		
WI 200-03-NKP	400	200	350		34.7		
WI 250-03-NKP	630	250	450		43.1		
WI 40-08	25	40	200	flanged	7.5	-	-
WI 50-08	25	50	200		8.1		
WI 65-08	40	65	200		9.6		
WI 80-08	63	80	225		12.0		
WI 100-08	100	100	250		14.7		
WI 125-08	160	125	250		18.7		
WI 150-08	250	150	300		24.5		
WI 200-08	400	200	350		34.6		
WI 250-08	630	250	450		43.0		

Meter versions:

-**03** - plastic counter cover, pre-equipped for NK transmitter modules, IP65 rotating counter

-**08** - rotating counter designed for IP68-rated induction communication modules

Connection flange bolt hole pattern:

- Standard: PN-EN 1092-2 (PN10), DIN 2532, DIN2501 (PN10), BS4504 (PN10)

Product features

- Easy counter reading
- Pre-equipped for optional induction communication modules (does not apply to NKP design)
- Hermetic counter (optionally rated at IP68)
- Counter mechanism rotation lock of 360°
- Double-sided rotor bearings
- Reliable readings



Heat metering

ELF 2

FAUN



Inductive rotor movement detection sensing with immunity to magnetic fields



Digital connectivity with ultrasonic sensors



Extensive configuration options



Measurement class 2 (PN-EN-1434)



Measurement class 2 (PN-EN-1434)



Various power supply options



Extensive archiving of measurement data



For operation in heating and/or cooling systems



For operation in heating and/or cooling systems



For operation in heating systems



Supports 2-wire temperature sensors



3 versions of body integrity



For operation in heating and cooling system (applies to Elf 2)



Battery-powered (for off-mains operation); optionally available with mains power connectivity



Digital connectivity with ultrasonic sensors



1/4 rotor turn detection



Interchangeable communication modules



Simultaneous operation with two independent and interchangeable communication modules



Supports 2-wire temperature sensors



Easy and convenient assembly, also on the transducer



Supports 2-4-wire temperature sensors



Battery-powered (for off-mains operation)



Large and clear LCD panel



Measurement starts from 0.1°C



Interchangeable communication modules



Extensive archiving of measurement data



Large memory size for over 5000 records



Easy and convenient installation



Extensive archiving of measurement data



Easy and convenient assembly, also on the transducer



Large and clear LCD panel



Large and clear LCD panel



Large and clear LCD panel



Multiple levels of configuration security

ELF 2

The latest-generation **complete** heat and cooling meter with a JS90-TI propeller flow sensor (DN15-20)

Application

The meter can work in heating and cooling systems operated in residential, office, and utility buildings, as well as individual apartments. The stylish design helps with seamless installation in any interior setting. The meter can measure heat or cold, or both heat and cold, within the same system. For installation in horizontal piping with the counter sideways (**H**) or in vertical piping (**V**).

The dynamic temperature measurement period and integration (2 to 6 s) makes the meter perfect for application in apartment-wide space heating and DHW subconnections ("Logothermas"). The extensive connectivity options enable operation in wired or wireless AMR systems and BMS (building automation systems).



ACCURACY CLASS:

- Class **2 (H)**
- Class **3 (V)**

Product features

- Latest, microprocessor-driven, multi-functional thermal meter
- One-button operation
- Battery-powered for off-mains operation
- Standard version: up to 6 years or optionally up to 12 years of maximum battery life
- Total immunity to external EM fields
- Flat error response of the flow meter
- High measurement accuracy (dynamic range: q_v/q_p 1:100)
- 2 m long sensor connection cable
- The meter parameters and functions are configurable before commissioning on site and include: energy units, installation location (supply or return end), input/output pulse weight, and more.
- IP65 rating
- Pt500 sensors included



Table 16. Basic technical data

Type	Dynamic range	q_p (m ³ /h)	DN (mm)	Length (mm)	Connection ends	Net weight (kg)
ELF 2* with JS90-YY-TI meter**	1:100 H; 1:50 V	0.6	15	110	G¾	0.58
		1	15	110	G¾	0.58
		1.5	15	110	G¾	0.58
		1.5	20	130	G1	0.68
		2.5	20	130	G1	0.68

* With a temperature sensor pair: one integrated with the body, the other in the connection T-pipe

** YY – nominal volumetric flow - q_p

- Medium temperature range: 5–105°C (With the heat meter installed on the return line. $t_{max} = 90^\circ\text{C}$ for the heat meter installed on the supply line)
- Nominal pressure: PN16
- Energy units: GJ, kWh lub Gcal

Interchangeable communication modules:

- M-Bus + 4 pulse inputs
- M-Bus + 2 pulse inputs + 1 pulse output
- RS485 Modbus enabled
- Wireless M-Bus T1 + 2 pulse inputs
- USB (service access)

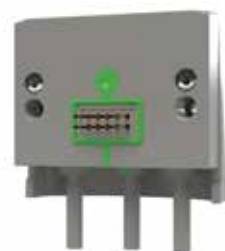

FAUN

Electronic calculator for heat and cooling **combined meters**

Application

FAUN is a high-precision, reliable, quality heat calculator for energy metering applications in heating and cooling water systems. The extensive communication options enable easy and reliable reading and transfer of measurement data. It is perfect for heating substations, residential or commercial buildings, and industrial installations.

Depending on the selected version and configuration, the calculator can be applied as a:

- Heating system heat meter
- Cooling system heat meter
- Integrated heating and cooling system heat meter



FAUN



Table 17. Specifications

FAUN heat meter electronic calculators		FAUN
Energy unit	–	GJ, MWh, kWh, or Gcal
Volume units	–	m ³
Temperature range limits	°C	$\Theta_{\min} = 1^{\circ}\text{C}$ $\Theta_{\max} = 180^{\circ}\text{C}$
Differential temperature range limits	°C	$\Delta\Theta_{\min} = 3^{\circ}\text{C}$ $\Delta\Theta_{\max} = 175^{\circ}\text{C}$
Nominal flow rate range	m ³ /h	0.6 to 3,000
Pulse constant range of the flow meter	dm ³ /pulse	1 to 10,000
	pulse/dm ³	0.01 to 300
MPE	%	$E_e = \pm (0.5 + \Delta\Theta_{\min} / \Delta\Theta)$
Compatible temperature sensors	–	Pt500 – 2- or 4-wire*
Compatible flow meters	–	Any if configured with pulse outputs
Cooling measurement switchover for operation in integrated heating and cooling single-cycle systems	–	Supply temp. < return temp. and supply temp. < preset threshold value
Power supply	–	Lithium battery, 3.6 V, type: AA, 2xAA, C or 24 V AC or 230 V AC power adapter*
Battery life	years	up to 6-12, depending on the battery type
Environmental class	PN-EN 1434	–
	MID	–
Ambient temperature	°C	5 to 55
Ingress protection rating	–	IP54 (standard) or IP65 (optionally available)

* Depending on the product version

Advantages

- Large and clear 8-segment display with an additional 4-segment indicator, multiple intuitive icons, and displayed value units
- Intuitive two-button operation
- Can be custom-configured with a dedicated service software suite (available for Windows PC)
- Manual configuration of select calculator parameters with the operating buttons
- Can be installed with two independent communication modules (without breaching the verification marking), with selectable communication protocol options
- The meter parameters and functions are configurable before commissioning on site and include: energy units, installation location (supply or return end), input/output pulse weight, and more.

Interchangeable communication modules:

- M-Bus
- RS232
- RS485
- Pulse outputs (x2)
- Pulse inputs and outputs (2 Class OB, OC, or OD outputs and 2 Class IB or IC inputs)
- Analogue outputs (x2, 0/4-20 mA or 0-10 V)
- LonWorks
- AT-WMBUS-MR-10 or AT-WMBUS-MR-10-1 wireless module
- IMR-AIUT telemetry RF module

JS90-NC | JS130-NC

Single-jet vane-wheel heat meter flow transducers (DN15-40)

Application

For integration with the indicating calculators in heat meters or for the measurement of water flow and volumes up to 90°C (JS90-NC) or 130°C (JS130-NC), MAP 16 bar (PN16). Recommended for installation in space heating and DHW supply systems of residential or industrial buildings. For installation in horizontal piping with the counter upward (**H**) or in vertical piping (**V**).



Measurement range (MID):

- JS90-NC range: $q_v/q_p = 1:50 - \mathbf{H}; 1:25 - \mathbf{V}$
- JS130-NC range: $q_v/q_p = 1:50 - \mathbf{H}; 1:10 - \mathbf{V}$

Table 18. Basic technical data

Type	q_p (m ³ /h)	DN (mm)	Length* (mm)	Connection ends	Net weight (kg)	Pulse value (dm ³ /pulse)
JS90-0,6-NC	0.6	15	110	G $\frac{3}{4}$	0.49	10
JS90-1-NC	1	15	110	G $\frac{3}{4}$	0.49	
JS90-1,5-NC	1.5	15	110	G $\frac{3}{4}$	0.49	
JS90-1,5-G1-NC	1.5	20	130	G1	0.56	
JS90-2,5-NC	2.5	20	130	G1	0.58	
JS130-3,5-NC	3.5	25	260	G1 $\frac{1}{4}$	2.2	
JS130-6-G1 $\frac{1}{4}$ -NC	6	25	260	G1 $\frac{1}{4}$	2.4	
JS130-6-NC	6	32	260	G1 $\frac{1}{2}$	2.4	
JS130-10-NC	10	40	300	G2	2.7	100

NC – reed relay transmitter with a standard 2 m connection cable for remote output of volume readings

* Other length options available on request

Product features

- Low starting flow
- Easy counter reading
- Hermetic counter
- Counter mechanism rotation lock of 358°
- Resistant to external magnetic fields
- Reliable readings

MWN130-NC

Heat meter propeller flow transducers (DN40-300)

Application

For integration with the indicating calculators in heat meters or for the measurement of water flow and volumes up to 130°C, MAP 16 bar (PN16). Recommended for installation in space heating supply systems of residential or industrial buildings. For installation in horizontal piping with the counter pointing upward (**H**) or in vertical piping with the counter pointing sideways (**V**).

Measurement range (MID):

- MWN130-NC range: $q_r/q_p = 1:25$ – H/V DN40-200
range: $q_r/q_p = 1:10$ – H/V DN250; 300



MWN130-NC

Table 19. Basic technical data

Type	q_p (m ³ /h)	DN (mm)	Length (mm)	Connection ends	Net weight (kg)	NC pulse value (dm ³ /pulse)
MWN130-40-NC	15	40	200	flanged	7.9	100
MWN130-50-NC	15	50	200		9.9	
MWN130-65-NC	25	65	200		10.6	
MWN130-80-NC	40	80	200*		13.3	
			225			
MWN130-100-NC	60	100	250		15.6	
MWN130-125-NC	100	125	250		18.1	
MWN130-150-NC	150	150	300		40.1	1000
MWN130-200-NC	250	200	350		51.1	
MWN130-250-NC	400	250	450		75.1	
MWN130-300-NC	600	300	500	103.1		

NC – reed relay transmitter with a standard 2 m connection cable for remote output of volume readings

Connection flange bolt hole pattern:

- Standard: PN-EN 1092-2 (PN10), DIN 2532, DIN2501 (PN10)
- Special: PN-EN 1092-2 (PN16) - available on request

* Available on request

Product features

- Wide measurement range with a low starting flow
- Removable measuring insert
- Hermetically sealed dial and barrel counter
- Resistant to external magnetic fields
- Reliable readings

TOP 1068

Wired resistive temperature sensors for combined heat meters based on the FAUN calculator, equivalent to TS200

Application

The TOP 1068 wired resistive temperature sensor pairs are intended for applications in pairs with heat meters. The sensors are based on Pt100 or Pt500 resistive elements. Each sensor features an external OG sheath with a threaded adapter.



Installation

- The sensors can only be installed in their external sheaths:
 - Square to the flow direction of the liquid heat medium;
 - 45° to the flow direction of the liquid heat medium, and with the sensor tip opposite to the flow direction;
 - In a piping bend, with the sensor tip opposite to the flow direction.
- The installation side of the sensor (supply or return) must conform to the colour-coded tagging (with red for the supply side and blue for the return side).
- Install the sensor with the sensing element at the centreline of the liquid heat medium.

Table 20. Basic technical data

Type		TOP 1068	
Temperature range	°C	$\Theta_{\min} = 0^{\circ}\text{C}$ $\Theta_{\max} = 150^{\circ}\text{C}$	
Differential temperature range	°C	$\Delta\Theta_{\min} = 3^{\circ}\text{C}$ $\Delta\Theta_{\max} = 150^{\circ}\text{C}$	
Measuring resistor	–	Pt500, PN-EN 60751:2009 class A or B	
Time constant	s	$T_{0.5} \leq 10.5$	
Maximum operating pressure (MOP) with the OG sheath	MPa	2.5	
Sensor sheath material	–	Brass / stainless steel	
Connection cable	–	Pair cord, 2x0.25 mm ²	
Wire resistance	Ω/m	approx. 0.15	
Wiring insulation	–	Silicone	
Maximum measurement current	Pt500	3 mA	
		1 mA	
Cable length	Pt500	1 to 3 m, in 0.5 m steps*	
		1 to 15 m, in 1 m steps*	
Minimum immersion depth	mm	25	
Ambient conditions	climate	–	5°C to 55°C
	mechanical	–	Class M2
	EM	–	Class E2
MID approval	–	PL 09 001/MI- 004	

* 3 m is standard

Temperature sensor and sheath sizing

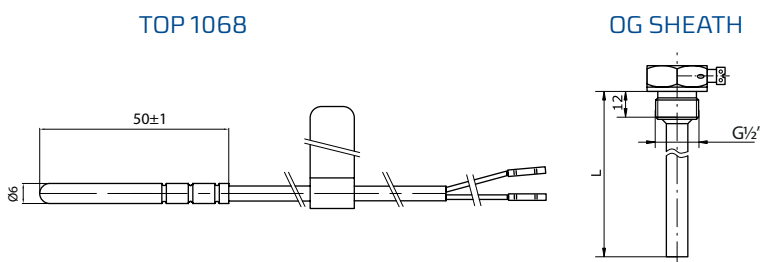

TOPE 41

Wired resistive temperature sensors for complete heat meters from Apator Powogaz, equivalent to TS400

Application

The TOPE 41 wired resistive temperature sensors are intended for applications in pairs with heat meters. The sensors are based on Pt100 or Pt500 resistive elements. The sensors are supplied in pairs only. The sensors can be installed in pair wells on tees and valves (for combined heat meter sizes DN15 and DN20) in a configuration with one sensor installed in the tee or valve and the other directly on the transducer, e.g. Sharky DN15 and DN20.



TOPGN 12/C*

Connection-head mount temperature sensors for heat meters

Application

The TOP 12 sensors are intended for liquid heat media temperature sensing applications, installed in pairs with heat meters. The sensors are based on Pt100 or Pt500 resistive elements. The sensors are installed directly in the piping.

* Equivalent to TSH 202 Pt500/250mm for the MWN130 250-NC meter and TSH 202 Pt500/400mm for the MWN130 300-NC meter. The sensors are sold only in complete kits of combined heat meters from Apator Powogaz.



TOP 146.1**

Connection-head mount temperature sensors for heat meters

Application

The TOP 146.1 temperature sensors are intended for applications in pairs with heat meters. The sensors are based on Pt100 or Pt500 resistive elements. Each sensor features an external 1H18N9T grade steel OG sheath with a threaded adapter.

** Equivalent TSH 202 Pt500/210mm for the MWN130 200-NC meter. The sensors are sold only in complete kits of combined heat meters from Apator Powogaz.



E-ITN 30.51 | E-ITN 40

A two-sensor electronic heating cost allocator.

The E-ITN heating cost allocator is intended for calculating and billing the costs of space heating in district heating systems. The recommended application scope includes horizontal or vertical single or two-pipe heating systems with the mean minimum / maximum design temperature of the heating medium 35°C / 105°C, depending on the device type.

Table 21. Basic technical data

Parameter	E-ITN 30.51	E-ITN 40
Outdoor reading range	< 250 m	< 300 m
Data protocol format	Wireless M-Bus	
Frequency range	868 MHz	
Transmitting power	< 5 mW	< 15 mW
Reading type	Visual, optical (IR interface), wireless WMBUS	Visual, NFC interface, or optional wireless (RF): Metra or WMBUS
Application range	$t_{\max} \leq 90^{\circ}\text{C};$ $t_{\min} \geq 35^{\circ}\text{C}$	$t_{\max} < 105^{\circ}\text{C};$ $t_{\min} > 35^{\circ}\text{C}$
Ingress protection rating	IP42	
Allocator type	Electronic, RF data transmission, unidirectional	Electronic, RF data transmission, bidirectional
Battery life	Up to 10 years + 1 year reserve	Up to 10 years + 2 year reserve
Dimensions	100 x 37 x 33 mm	100 x 41 x 31 mm



E-ITN 30.51

E-ITN 40

Advantages

- 3 indication reading options:
 - visual (direct reading of the display)
 - with an IRU optical reader
 - over an RF module and NFC, applicable to E-ITN 40
- The heating cost allocator features a conveniently positioned LCD for easy reading of current heat consumption values. The data is logged in an integrated memory module. This enables end-to-end analysis of heat consumption and in-heating season operating conditions.
- Aside from precision measurement of radiator temperature, the E-ITN heating cost allocator supports logging of mean indoor temperatures at the installation location. The heating cost allocator is driven by a software which measures the actual heat consumption at the connected flat and the heat supplied from the heating risers and the heat exchange between the adjacent units in the building.
- Every attempt at unauthorized tampering (by breaking the electronic tamper seal) is logged with a precise timestamp. Each tamper event is output during the next RF reading.



AMR (automatic meter reading) systems

RF AMR

Application

Reading of water meters, heat meters, cooling meters, and heating cost allocators installed in residential, building or commercial / industrial buildings. The RF AMR system is based on a PN-EN 13757 Wireless M-Bus compliant communication protocol operating in the 868 MHz band with a unidirectional reading mode (T1) and a bidirectional configuration mode (T2). Select models feature a configurable RF data frame transmission interval (in months, days, and hours).

Communication

Depending on the device type, RF module model and the configuration, the RF data output can feature different data types (see the product specification sheets for details). Examples of RF data outputs:

Water meters / heat and cooling meters – serial number, reading date, actual reading value, monthly reading history, events.

Heating cost allocators – serial number, reading date, actual reading value, mean radiator temperature, mean indoor temperature, billing period start date, events.

Data reading methods

- **MOBILE** (walk-by / drive-by) – a meter reading method with potential manual input of the readings from the meters.
- **STATIONARY** – an AMR method implemented in a stationary AMR network, where the data are output live to a telemetric server.

Advantages

- Short meter reading round times and optimised utilization of resources
- Eliminates human error
- Reading of device units installed in inaccessible locations and/or with the consuming tenants absent from the premises
- Reduced billing period duration for improved financial fluidity of the utility provider
- Billing per actual consumption
- Fast response to undesired events
- Low reading costs per device unit

AMR schematic diagram

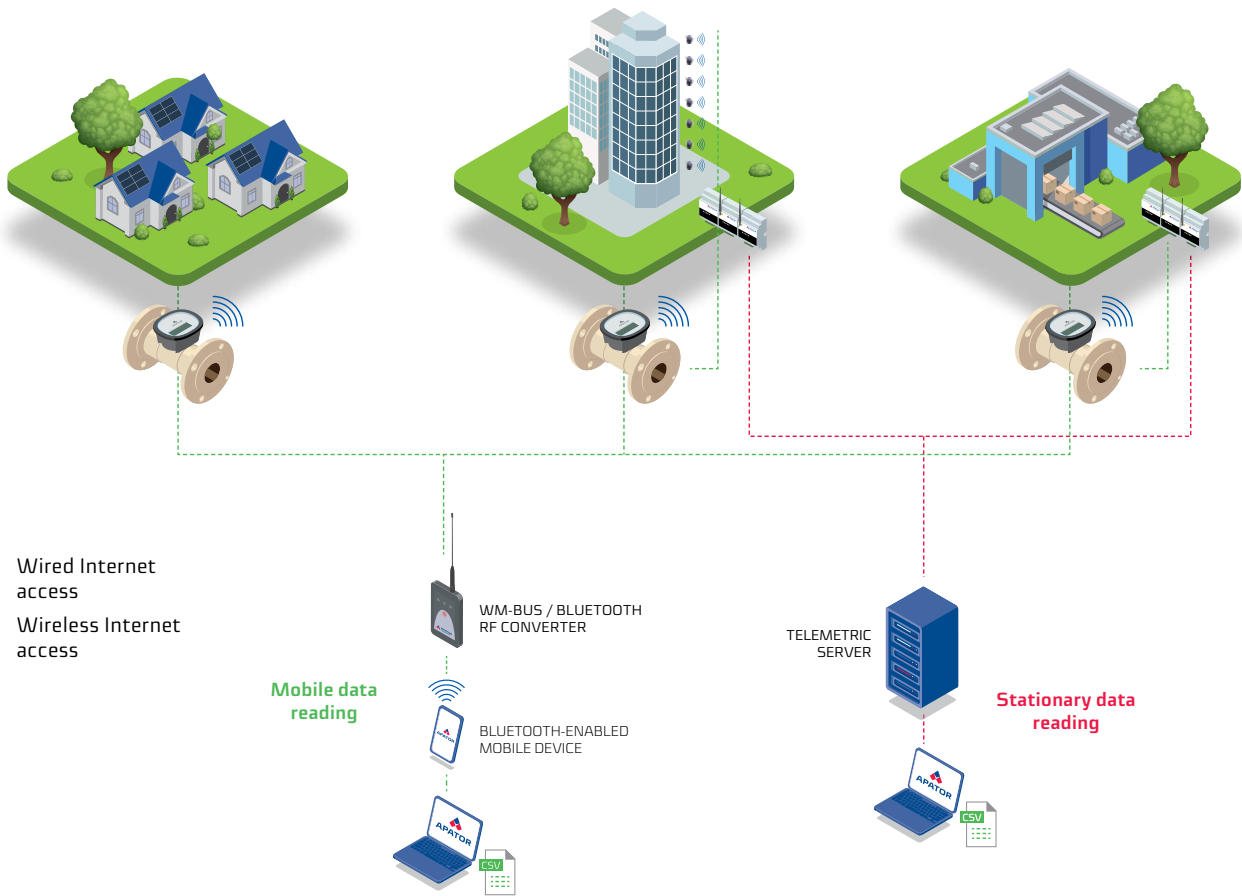

Mobile AMR: configuration examples

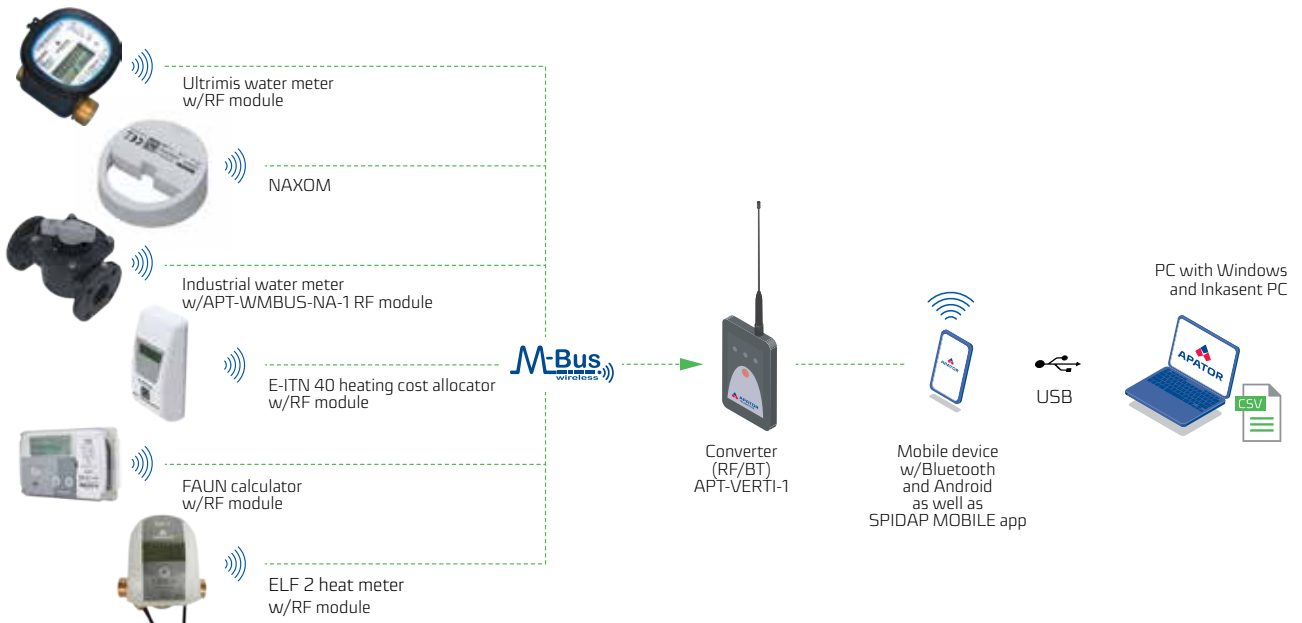

Stationary AMR: configuration examples

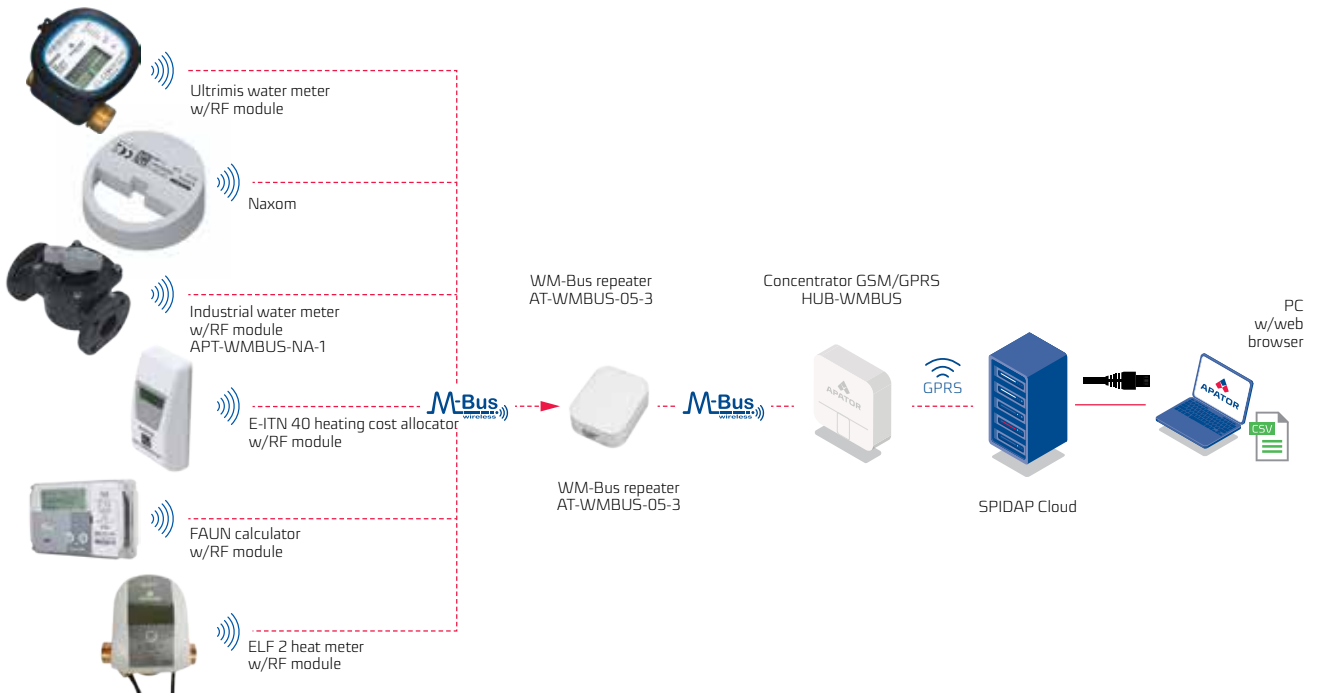

SPIDAP MOBILE APP

This is a mobile collector data acquisition method by automatic reading of the wireless output from the RF transmission modules installed on meters. A collector who has a mobile terminal with the SPIDAP app installed and a Bluetooth interface enabled, plus the APT-Verti-1 data communication module follows a predefined route, either from building to building by foot (walk-by) or in a vehicle (drive-by).

Basic software functionalities:

- Reading of utility meter data along the reading routes generated in Inkasent PC
- Supports manual reading and input of metering data
- Provides diagnostic features for meters and RF modules
- Enables configuration programming of water meter RF modules

STATIONARY AMR SYSTEM

SPIDAP CLOUD

The software suite is dedicated for the operation of stationary RF AMR (automatic meter reading) systems. The system is a part of a telemetric server the primary use of which is reading the measurement device data over an RF transmission network, acquisition of the data and its processing. The software applications requires Internet connectivity and a web browser.

Basic software functionalities:

- AMR transmission and metering structure creation and management (with a meter address database + measurement points)
- Acquisition and storage of meter reading and diagnostic data
- Task scheduling (periodic meter reading acquisition, reporting, and more)
- Data analysis and visual output
- Master + slave meter billing reporting
- Data export to third-party systems
- System user account setup and management

RF AMR SYSTEM DEVICES

MOBILE DEVICES

An Android OS smartphone or another Android device with the dedicated SPIDAP application installed for remote RF configuration programming and reading data of measurement device communication modules. The mobile device communicates with the AMR terminal devices WM-Bus and an RF-BT/USB converter.

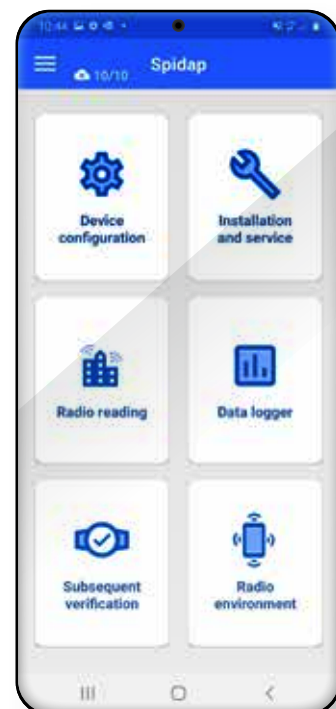

APT-VERTI-1 RF-BT/USB CONVERTER

The APT-VERTI-1 converter is an RF intermediate transmission device between RF data output modules of meters and the meter data collector's installed on a mobile device, which serves as a reading terminal. Its main task is to convert the signal between the RF modules which operate in the unlicensed ISM 868.95 MHz band and the BT/USB interface. The communication with the converter is handled via the SPIDAP or Ceris Reader app installed on the mobile terminal. The mobile terminal listens for and receives the spontaneous T1 mode RF data frames, and can also read the RF module configuration data in the two-way T2 mode. APT-Verti-1 works in one-way C1 transmission mode as well.

Table 22. Basic technical data

Parameter	APT-VERTI-1
Transmission frequency	868.95 MHz in T1 868.30 MHz in T2
Power supply	Li-ion battery pack
Continuous operating time	max. 24 h
Operating temperature range	0°C to 60°C
Ingress protection rating	IP30
Net weight	0.130 kg



APT-VERTI-1

AT-WM-BUS-05-3 REPEATER

An RF repeater mediates in the RF data communication between RF modules and an RF concentrator. The RF repeater extends the maximum range between the devices. The RF repeater accepts the RF data frames and retransmits them to the receiver.

Product features

- Wall mounted with quick mount wall plugs or screws
- The transmission line can be extended with a maximum of 8 RF repeaters
- 230 V mains power supply
- Continuous operation
- Compatible with AMR and transmission structure devices over Wireless M-Bus
- Hermetically IP67 enclosure with cable glands (for the AT-WMBUS-05-3h and AT-WMBUS-05-3d versions)



AT-WMBUS-05-3



AT-WMBUS-05-3h

Table 25. Basic technical data

Parameter	AT-WMBUS-05-3	AT-WMBUS-05-3h
Communication protocol	Wireless M-Bus (T1)	Wireless M-Bus (T1)
Transmission frequency	868 MHz	868 MHz
Modulation	FSK, frequency deviation: ± 50 kHz	FSK, frequency deviation: ± 50 kHz
Antenna	internal	internal
Transmitter power output	10 mW / 50 Ω	10 mW / 50 Ω
Receiver sensitivity	-100 dBm	-100 dBm
Power supply	Mains	Mains
Ingress protection rating	IP54	IP67
Dimensions	110 x 81 x 40 mm	120 x 80 x 55 mm
Operating temperature	-20°C to 55°C	-20°C to 55°C

RF DATA HUB

A hub is one of the basic devices in network telemetry. Its function is to collect measurements transmitted from various utility metering devices. HUB-WMBUS collects the data compliant with the Wireless M-Bus OMS protocol regardless of the meter's manufacturer and for all utilities. The collected data are uploaded to the SPIDAP Cloud system via the Internet over the GSM. The device can read data from up to 1,600 devices and transmit it to a telemetry server. Communication in the FXN network happens via radio waves in the Wireless M-Bus protocol using the ISM 868 MHz band.

HUB-WMBUS-BAT

HUB-WMBUS-230

The hub is available in two versions: battery-powered (HUB-WMBUS-BAT) and mains-powered (HUB-WMBUS-230). Once connected to power supply, the device automatically connects to the manufacturer's server from which it downloads the address of the target server. From the server level, it is possible to configure the GSM transmission, time, and filters defining which devices are to be included and which are to be omitted based on the frame header. HUB-WMBUS is used to build ISM - FXN fixed radio network systems in urban and industrial settings. The device is installed indoors and can collect readings from metering devices such as water meters, heat meters, heat cost allocators, gas meters, and electricity meters.

Key features

- IP-54 rated case
- Compact size
- Fast and simple installation
- Detection and alerting of significant events such as:
 - dismantling,
 - breached/closed case,
 - power failure – for the mains-powered model,
 - low battery – for the battery-powered model,
 - battery over-discharge – for the battery-powered model,
 - the CPU reset,
 - minimum operating temperature exceeded,
 - maximum operating temperature exceeded.



Table 26. Basic technical data

Parametr	HUB-WMBUS-Bat/230
Communication mode	Wireless M-Bus OMS modes C1 and T1 parallelly
Transmission frequency	868 MHz
Wireless MBus encryption	AES, key length 128 bit
Data security	TLS secured communication protocol Encrypted data in flash memory
Power supply	For the HUB-WMBUS-Bat model – two M20CV batteries (3VDC, battery capacity 25 Ah) For the HUB-WMBUS-230 model – 230 VAC/50Hz/10W
GSM module	EG915N-EU module Bands: 800, 900, 1800, 2100, 2600 MHz LTE cat. 1 class
SIM card	Mini SIM card 2FF / eSIM
Sensitivity	-115 dBm
Transmitting power	4dBm
Battery life (configuration-dependent) *	Up to 6 years *with the GSM transmission once a day, maintaining the specified temperature profile
Temperature profile	80% of operating time below 30°C 10% of operating time between 30°C and 40°C 7% of operating time between 40°C and 50°C 3% of operating time over 50°C
Operating temperature	from 5°C to 55°C
Degree of protection	IP54
Conditions	For indoor use
Service module	USB type C connector
Firmware update	The hub allows remote software updates via the GSM
Case material	PC
Case dimensions	179,8 x 174,8 x 47,50 mm
Weight	620 g (HUB-WMBUS-Bat)
	415 g (HUB-WMBUS-230)

SUPPORTED EVENT ICONS



Maximum flow



Minimum flow



Back flow



Measurement Unchanged



Leak



Water meter communication module disconnected



Magnetic field



Strong light detection



Low battery

RF AMR WATER METER ADD-ON MODULES

AT-WMBUS-04 | AT-WMBUS-04-1 RF MODULE

APT-WMBUS-NA-1 RF MODULE

A universal RF module intended for direct installation on the counter mechanisms of water meters from Apator Powogaz S.A. with induction pointers.

The RF module provides wireless output of measurement data in AMR walk-by and drive-by systems (with a power output of 20 mW and a maximum outdoor service range of 800 m). The induction scanning mechanisms of the counter pointer is an excellent solution for heavy-duty operating conditions (including wet water meter chambers prone to flooding).



Product features

- Quick and easy configuration with mobile devices
- Spontaneous transmission (T1): RF data frame output at a fixed transmission interval of 10 s (between 5:00 and 21:00) and 60 s (between 21:00 and 5:00)
- Memory of 12 historical water meter readings, as configured by the user, and with the memory reading on request (T2)
- Detection, logging and indication of water usage abnormalities and RF module performance abnormalities
- Supports an external antenna for a greater RF range
- Features NFC (near-field communication) for switching from the warehouse mode to the operating mode, actual and historical measurement data reading and detailed event reading

Compatible after meters:

- **The device is designed to work with residential (DN15–20), home (DN25–40) and industrial (DN40–400) water meters from Apator Powogaz S.A., equipped with a dedicated induction pointer (T1).**



Table 27. Basic technical data

Module	APT-WMBUS-NA-1 (IN-WMBUS)	APT-WMBUS-NA-1 M (IN-WMBUS ant3)
Antenna	Internal (standard version)	Ext. antenna line L = 3 m
Installation method	Water meter interface ring – not present in IP68-rated water meters	
Pulse counting method	Induction resonance module	
Power supply	3.6 VA lithium battery	
Battery life	Up to 12 years of operation + 1 years in warehouse mode with a temperature profile: 10% of operating time at 10°C, 80% of operating time at 20°C, 10% of operating time at 30°C	
	Up to 6 years of operation + 1 years in warehouse mode with a temperature profile: 100% of operating time at 60°C**	
Operating temperature	-15°C to 60°C	
Ingress protection rating	IP68	
Transmission type	Unidirectional (T1): consumption data and event flags Bidirectional (T2) consumption data, diagnostic data, and event details (configuration)	
Transmission interval	10 s from 05:00 to 21:00 60 s from 21:00 to 05:00	
Protocol	Wireless M-Bus	
Transmission frequency	868.95 MHz	
Transmitter power output	20 mW / 50 Ω	
Transmitter power output level stability	+1 dB / -2 dB	
Receiver sensitivity	-100 dBm	
Net weight	0.106 kg	0.138 kg

** For temperature class T130 and T50 water meters

IN-GSM MODULE

The IN-GSM universal induction communication module is intended for acquisition of readings from water meters manufactured by Apator Powogaz S.A. and transmission of the measurement data over GPRS in GSM (cellular) networks. The module is installed on the water meter with or without an interface ring.

The module features inductive scanning of the water meter counter pointer, and with the module's IP68 protection rating, it is dedicated particularly for installation on water meters in difficult ambient conditions (including wet water meter vaults at risk of flooding with water).



Product features

- Easy and quick configuration with dedicated software
- Supports custom configuration of the data transmission interval
- Asynchronous indication of alarms immediately when set (maximum of 5 alarms a month)
- Detection, logging and indication of water usage abnormalities and module performance abnormalities by indication of events
- Supports Eco mode – switching the data transmission mode from GPRS to binary text messages (PDU)

Compatible water meters:

- **The device is designed to work with residential (DN15–20), home (DN25–40) and industrial (DN40–400) water meters from Apator Powogaz S.A., equipped with a dedicated induction pointer (TI).**



Table 28. Basic technical data

Module	IN-GSM	IN-GSM-ANT3
Antenna	Internal PCB-mounted antenna	External Gain = 1 VSWR ≤ 2 antenna cable length 3 m
Installation method	With or without an interface ring (depending on the water meter version, IP65 or IP68) on the water meter counter – mechanical lock (installation seal) for protection against unauthorised removal of the module.	
Installation orientation	Horizontal or vertical	
Device operating time	Up to 6 years, depending on the configuration* and operating temperature**. * Logging the water meter status every 1 h, data transmission every 24 h; monitoring/flow monitor mode run up to 24 times over the product service life (maximum status logging frequency 10 min, data transmission every 24 h for up to 7 days); up to transmitted every month. 5 alarms per month. ** Module operation in the following temperature ranges: 10% of operating time at 10°C, 80% of operating time at 20°C, and 10% of operating time at 30°C	
Correct performance temperature limits	-15°C to 60°C	
Ingress protection rating	IP68	
Installation requirements	Do not use near strong EM fields or in locations which can severely attenuate the GSM service.	
Transmission interval	1m, 2m, 5m, 10m, 15m, 30m, 1h, 2h, 4h, 6h, 8h, 12h, 1d, 2d, 3d, 4d, 5d, 6d, 7d, 10d, 15d, 1 month	
SIM card	USIM, type MFF2	
Power supply	Replaceable M20 lithium battery (serviced by authorised technicians or the customer), nominal voltage 3.0 V, max. capacity 12.5 Ah	
Transmission type	NFC, compliant with ISO/IEC 15693, 13.56 MHz GPRS; SMS/PDU binary SMS	
Protocol	ATDP	
GSM modem	2G, 900 MHz/1800 MHz	
Transmitter power output	min. 5 dBm, max. 33 dBm	
Power output level stability	±5 dB	
Receiver sensitivity	< -109 dBm	
Outdoor range	Depending on the landscape configuration and the distance to and location of the BTS	
Memory	13312 entries	
Dimensions	175.6x88.3x52.1	
Net weight	0.433 kg	

NAXOM OP-04-1 RF MODULE NAXOM OP-04-2

The OP-04-1 optical RF module for Wireless M-Bus connectivity is intended for installation on the JS Smart single-jet water meters made by Apator Powogaz. The module acquires the water meter readings and outputs the measurement data over the Open Metering System (OMS) communication protocol. The module is available in two design versions: model "a" with a ½ AA battery and model "b" with a ⅔ AA battery. The OP-04-2 communication module is intended for installation on SV-RTK volumetric water meters and available as a model with an AA battery. The communication modules can work with a wide range of devices, creating an AMR and transmission structure.

Product features

- Quick configuration with mobile devices
- Water meter type selection and configurable water meter-related properties
- Compatible with AMR and transmission structure devices compliant with the
- Open Metering System Vol.3 or Vol.4 specifications
- Storing and reading the measured volume data from 1 to 16 months

Compatible water meters:

- **OP-04-1:**
JS and JS90 1,6 to 4,0 Smart+
JS 1,6 to 4,0 Smart C+
JS and JS90 1,6 to 4,0 Smart D+
- **OP-04-2:**
SV-RTK 2,5, SV-RTK 4,0 , SV-RTK 16



Table 29. Basic technical data

Module	OP-04-1a	OP-04-1b	OP-04-2
Communication standard	OMS3 no security, OMS3 security mode 5, OMS4 security mode 5, OMS4 security mode 7		
Power supply	3 V battery, ½AA	3 V battery, ⅔AA	3 V battery, AA
Operating temperature	0°C to 55°C		
Signal output	Internal antenna		
Transmission frequency	868 MHz		
Communication protocol	Wireless M-Bus		
Consumption detection	Optical		
Power output	10 mW/50 Ω		
Power output level stability	+1 dB / -3 dB		
Sensitivity	-108 dBm		
Battery life	12 years max.*		
Outdoor range	350 m		
Ingress protection rating	IP65		
Installation method	Directly on the water meter		
Dimensions	h = 26.4 mm s = 67.6 mm	h = 34.9 mm s = 67.6 mm	h = 44.1 mm s = 69.7 mm
Net weight	36 g	43 g	53 g

* Depending on the transmission profile configuration.



OP-04-1a



OP-04-1b



OP-04-2

APT-03A-3 MODULES

The APT-03A-3 is designed for apartment and home water meter reading via wireless data transmission. Data is transmitted wirelessly over Wireless M-Bus radio connectivity in accordance with PN-EN 13757. The APT-03A-3 is compatible with OMS devices.

Product features

- Easy and quick configuration with mobile devices
- Storing and reading the volume data from 1 to 16 months
- Detection, logging and indication of water usage abnormalities and RF module performance abnormalities to adjust the data transmission period and interval as required by the user
- Compatible with AMR and data transmission structure devices in compliance with the Open Metering System Vol. 3 specifications
- Supports an external antenna for a greater RF range
- 300 m of maximum outdoor range



APT-03A-3



APT-03A-3
w/external antenna

Table 30. Basic technical data

Module	APT-03A-3 2.65.1.1.03	APT-03A-3 2.65.H.1.09
Water meter	JS and JS130 6,3 to 16 Master+ /C+/D+	
Communication protocol	Wireless M-Bus	
Transmission frequency	868.95 MHz	
Consumption detection	Optical	
Power supply	Lithium battery, 3.6 V / AA	
Ingress protection rating	IP65	
Signal output	Internal antenna	External antenna w/2 m cable
Battery life (configuration- dependent)	10 years max.*	
Output antenna power	10 mW / 50 Ω	
Dimensions	h = 44.1 mm; φ = 65.5 mm	
Operating temperature	0°C to 55°C	
Net weight	0.056 kg	0.065 kg

* For temperature class T30 and T50 water meters operating at 25°C ambient temperature

An outdoor RF module intended for water meters with NK pulse transmitter modules.
Power output: 10 mW; outdoor service range: 300 m.

Compatible water meters:

- All models with NK / NO* transmitter modules



Table 32. Basic technical data

AT-WMBUS-04

Parameter	AT-WMBUS-04	AT-WMBUS-04-1
Outdoor reading range	< 300 m	< 300 m
Data protocol format	Wireless M-Bus	Wireless M-Bus
Frequency range	868.95 MHz	868.95 MHz
Power output	10 mW / 50 Ω	10 mW / 50 Ω
Ingress protection rating	IP65	IP68
Net weight	0.180 kg	0.180 kg

* Compatible with NO transmitter modules if an auxiliary 5-24 V DC power supply source is connected.

WIRED AMR SYSTEMS

Application

Remote reading of water meters and heat and cooling meters installed in residential buildings or commercial / industrial buildings. The AMR system is based on the M-Bus communication protocol or pulse outputs. For the M-Bus communication option, the total wiring length in the AMR network must be 1 km or less. The maximum number of network nodes (communication modules) is 250, which can be multiplied with each connected M-Bus Master converter. The M-Bus Master converter enables reading of the data from the communication modules and relay of the data over a wired or wireless link (via the Internet) to the AMR software installed on a PC.

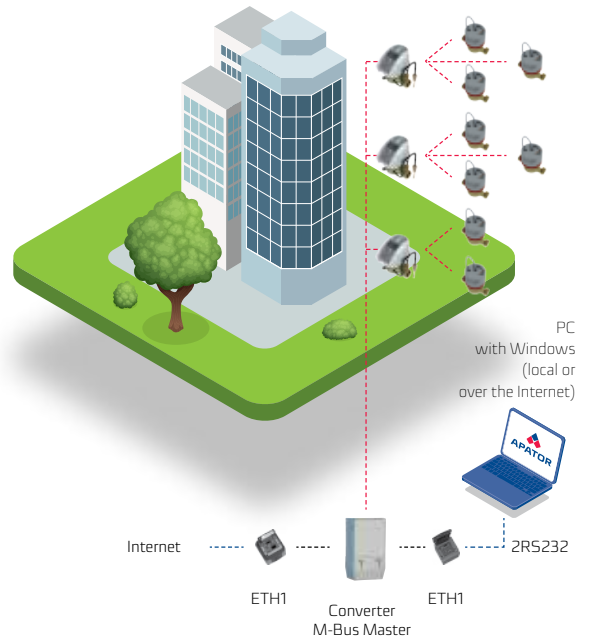

Communication

Depending on the measurement device type and the RF module type and configuration, the data output can feature different data types (see the product specification sheets for details). Examples of transmitted data outputs:

Water meters / heat and cooling meters – serial number, reading date, actual reading value, monthly reading history, events.

Data reading methods

- Stationary – an AMR method implemented in a stationary AMR network the data from which are output live to an AMR software application.

Advantages

- Short meter reading round times and optimised utilization of resources
- Eliminates human error
- Reading of device units installed in inaccessible locations and/or with the consuming tenants absent from the premises
- Reduced billing period duration for improved financial fluidity of the utility provider
- Billing per actual consumption
- Fast response to undesired events
- Low reading costs per device unit
- Low AMR transmission network deployment costs: a network of 250 nodes (communication modules) requires just one concentrator
- Reading of measurement device at any time required
- Enable pulse-output based connection between water meters and the M-Bus module of the heat meters to reduce the required number of network nodes

WIRED AMR SYSTEM SOFTWARE

The Flat Standard software is dedicated for AMR of actual and archive data and events from the measurement devices with M-Bus wired modules installed. The software application was developed for Windows PCs.

Basic software functionalities:

- AMR structure creation and management (with a meter address database + measurement points)
- AMR structure import / export from / to file
- Visual output of measurement data, historical data and diagnostic data acquired over the wired network
- Enables invalidation of historical events output by the measurement devices
- Enables configuration programming of water meter wired modules

WIRED AMR SYSTEM DEVICES

M-BUS converters

- M-Bus Master 400
- M-Bus Master 60
- M-Bus Master 10+

Ethernet remote data reading converter

- Eth1
- Eth2

Local data reading converter

- RS232/USB

WIRED AMR WATER METER ADD-ON MODULES

APT-MBUS-NA-1 | APT-MBUS-NA-2 | APT-MBUS-NA-4 MODULES

An optical M-Bus module is designed for direct installation on the counter mechanism of Apator Powogaz S.A. water meters. The device directly transmits the water meter readings to the wired M-Bus network.

Product features

- The product features a system of optical sensors for optical reading of water meter data and detection of the water flow direction, which makes the reading completely accurate with the water meter readings.
- Detection, logging and indication of water usage abnormalities and RF module performance abnormalities

Compatible water meters:

- APT-MBUS-NA-1-C – JS/JS90 1.6 to 4.0 Smart series
- APT-MBUS-NA-2-C – JS/JS90 6.3 to 16 Master Series
- APT-MBUS-NA-4-C – JS 50÷100, MWN/MWN130 40÷300, MK 50÷150



APT-MBUS-NA-1



APT-MBUS-NA-2;-4

Table 33. Basic technical data

Parameter	APT-MBUS-NA-1	APT-MBUS-NA-2;-4
Communication protocol	M-Bus with the manufacturer's layer	M-Bus with the manufacturer's layer
Consumption detection	Optical	Optical
Pulse outputs	2 (OD)	2 (OD)
Power supply	Lithium battery, 3.6 V / ½ AA	Lithium battery, 3.6 V / AA
Ingress protection rating	IP65	IP65
Battery life	10 years max.*	10 years max.*
Cable	YTLY 2x0.14 mm ²	YTLY 2x0.14 mm ²
Cable length	1.5 m	1.5 m
Dimensions	h = 26.2 mm; φ = 65.5 mm	h = 44.1 mm; φ = 65.5 mm
Operating temperature	0°C to 60°C	0°C to 60°C

* When the module is connected to the M-Bus network, the battery life at an ambient temperature of 25°C is up to 5 years.

AT-MBUS-NE-01 | -02 | -03 MODULE

The AT-MBUS-NE optical pulse module is designed for direct installation on the counter mechanism of Apator Powogaz S.A. water meters. The device transmits the water meter readings directly to receivers with a pulse input interface. The pulse value and two pulse output types can be specified on custom order.

Product features

- The product features a system of optical sensors for optical reading of water meter data and detection of the water flow direction, which makes the reading completely accurate with the water meter readings.
- Enables selection of the pulse mode for each pulse output
- Detection, logging and indication of water usage abnormalities and RF module performance abnormalities over a wired configuration interface
- The pulse output is NC; each pulse breaks the output at 250 ms

Compatible water meters:

- AT-MBUS-NE-01 – **JS 50÷100, MWN/MWN130 40÷300, MK 50÷150**
- AT-MBUS-NE-02 – **JS/JS90 1.6 to 4.0 Smart series**
- AT-MBUS-NE-03 – **JS/JS90 6.3 to 16 Master Series**



AT-MBUS-NE-01 and -03



AT-MBUS-NE-02

Table 34. Basic technical data

Parameter	AT-MBUS-NE-01, -03	AT-MBUS-NE-02
Consumption detection	Optical	
Pulse outputs	2 (type OD)	
Power supply	Lithium battery, 3.6 V / AA	
Ingress protection rating	IP65	
Battery life	10 years max.*	
Cable	VTLY 4x0.14 mm ²	
Cable length	1.5 m	
Dimensions	h = 44.1 mm; φ = 65.5 mm	h = 26.2 mm; φ = 65.5 mm
Operating temperature	0°C to 60°C	

* For temperature class T30 and T50 water meters operating at 25°C ambient temperature

Wired IN-PULSE module

The PULSE-NE universal induction pulse module is designed for remote reading of Apator Powogaz S.A. water meters. The water meter connectivity is based on induction scanning of the counter pointer. The measurement data is output to external devices through two pulse outputs. The pulse value and two pulse output types can be specified on custom order.



Product features

- Data configuration, reading and writing over NFC
- Easy and quick configuration with a dedicated mobile application
- Compatible with Apator Powogaz water meters designed for induction pulse modules

Compatible water meters:

- The device is designed to work with residential (DN15–20), home (DN25–40) and industrial (DN40–400) water meters from Apator Powogaz S.A., equipped with a dedicated induction pointer (TI).



Table 35. Basic technical data

Module	IN-PULSE
Installation method	With or without a locating interface ring on Apator Powogaz S.A. water meters
Connection cable	5-wire, length: 3 m
Pulse outputs	2
Pulse width	65 ms
Contact make resistance	70 Ω max.
Short-circuit current	100 mA max.
Maximum voltage	30 V
Power supply	3.6 VA lithium battery
Battery life	up to 12 years
Correct performance temperature limits	-15°C to 60°C
Ingress protection rating	IP68
Dimensions	130x73x42.7 mm
Net weight	0.106 kg

SPIDAP SOFTWARE - COMPREHENSIVE SOLUTIONS FROM INSTALLATION TO BILLING AND MORE

Our products are the premier choice for digital transformation providing sustainable solutions for efficient and conscious energy and water management.

Boosting energy efficiency requires a holistic strategy involving every player in the energy supply chain, from production to consumption. Although making small gains in production efficiency and cutting transmission losses matters, the real game-changer lies in empowering end-users to optimize their energy usage. That's where the magic happens!!

Reading systems

The system enables data collection through variable meter reading methods either walk-by / drive-by modes, or local stationary ISM 868 networks connected to the internet via data concentrators. It also supports stationary LoRa WAN networks covering large areas. Additionally, it can receive data peer-to-peer (P2P) from embedded modules or overlays installed on measurement devices, utilizing NB-IoT or GSM communication..

walk-by/drive-by system

Data collection is facilitated by short-range radio modules installed on the measurement devices, covering specific reading routes in dense or scattered urban areas. This method eliminates the need for manual meter checks, as the collected data is transmitted by the collector to the system administrator.

Stationary ISM 868 MHz system

The data collection is facilitated by short-range radio modules mounted on the measurement devices, following a designated route determined by the location of transmitters and a sending concentrator, which transmits the data to telemetry servers. This method of reading is particularly effective in densely populated areas.

LoRaWAN system

The data collection is carried out through long-range radio modules. Readings are captured by "gateway" base stations and then transmitted to the operator, who stores the reading data in the cloud with unrestricted access for the client.

NB-IoT / GSM system

Point-to-point (P2P) reading is facilitated by a communication overlay's collaboration with a wide range of residential, household, and industrial water meters. Reading accuracy is ensured through the utilization of the evolving infrastructure provided by cellular network operators. This method is commonly employed when monitoring device and network operation is necessary. Alarms are signaled immediately upon their occurrence.

SPIDAP system structure

The SPIDAP system is divided into several modules that cooperate with each other:

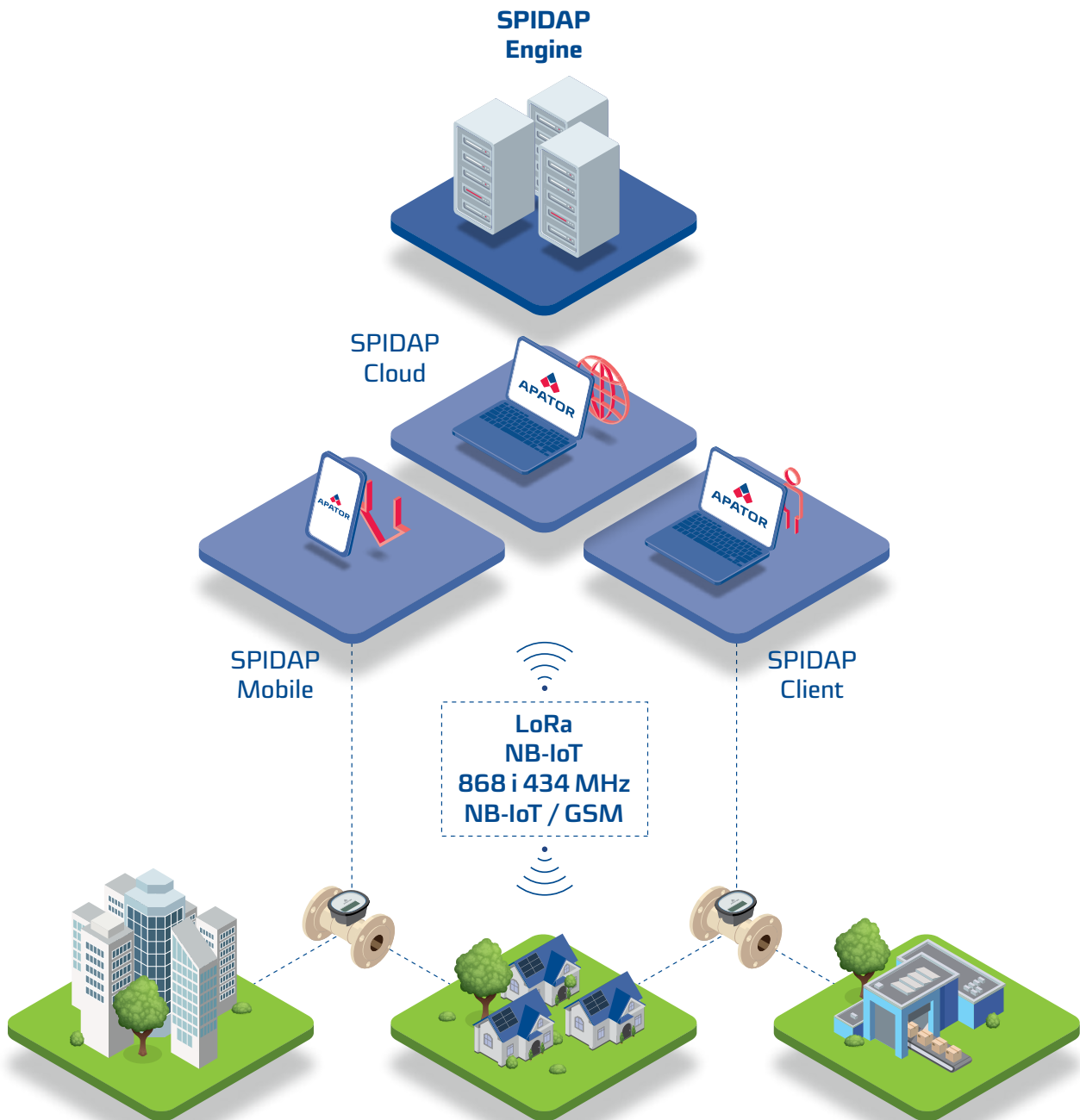

It is possible to integrate the SPIDAP system with measurement and communication devices from other manufacturers. Details at Apator Powogaz Sales Representatives.

The main task of the SPIDAP.cloud platform includes

- Collecting and storing data: readings, diagnostics, and events.
- Managing reading schedules for the transmission network.
- Presenting & processing the collected data.
- Flexible data export to external billing systems used by our clients.
- Creating a measurement structure enabling the creation of reading routes for previously installed devices.
- Creating reading routes for collectors and transmitting the collected data through the cloud.
- Archiving data in one central location.

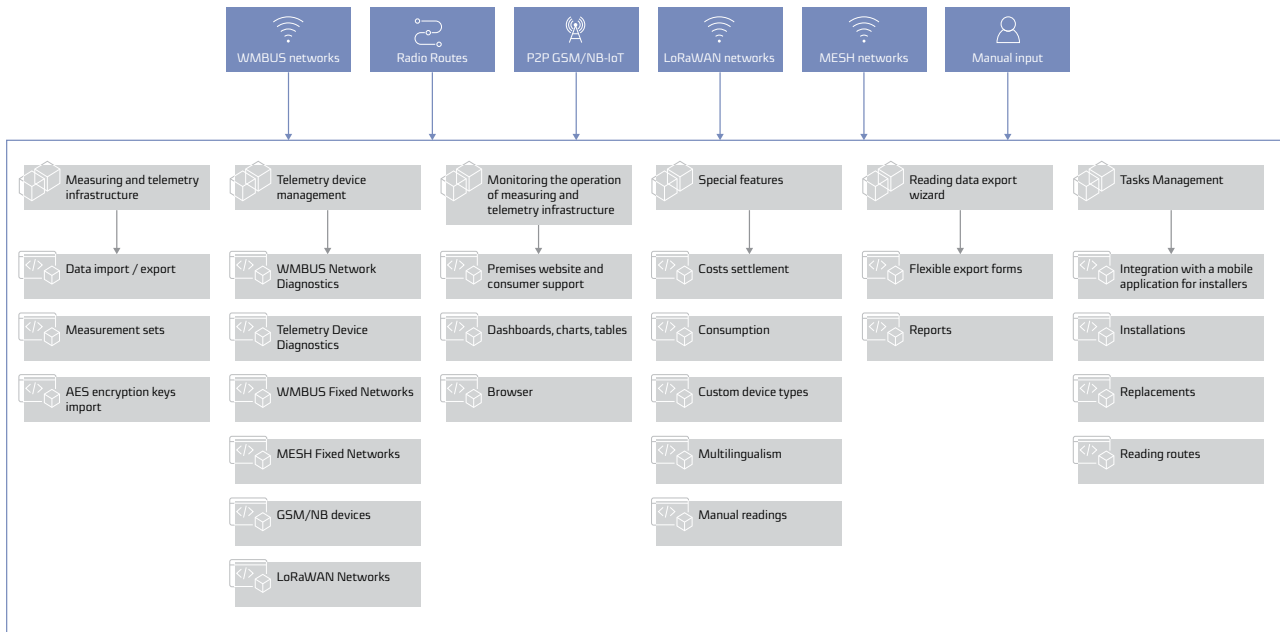

Measurement sets

A measurement set establishes a connection between measuring devices and telemetry devices situated at a specific location. This system exclusively gathers and processes data from devices incorporated within the measurement set. Measurement sets can be created using the user interface wizard or via a designated import tool. Through a unified process, users can add both measuring and telemetry devices along with the installation location of the measurement set. After specifying the installation date, the set is prepared for operation.

The quantity of devices within a measurement set is unrestricted. Typically, a measurement set comprises a pair: a measuring device and a telemetry device. However, a measurement set may also be constituted by a single device (e.g., a heating cost allocator, a water meter featuring an integrated telemetry module).

Device Replacement

Sometimes something breaks, someone damages a device, or the device's legalization period expires. By using the replacement wizard in the user interface, you can quickly replace both measuring and telemetry devices. Each device replacement automatically deactivates the existing measurement set and creates a new one. If you are replacing a metering device that is read by the stationary network, the old device will be automatically removed from it and replaced with a new one.

SPIDAP Mobile

SPIDAP Mobile is an easy-to-use and intuitive tool for collector readings, supporting the installation process, device exchanges, and investment management. It saves time at every stage of work, improving the efficiency of handling mass quantities of devices, which can be managed by internal staff or external companies. The software's goal is to replace paper-based protocols with electronic ones.

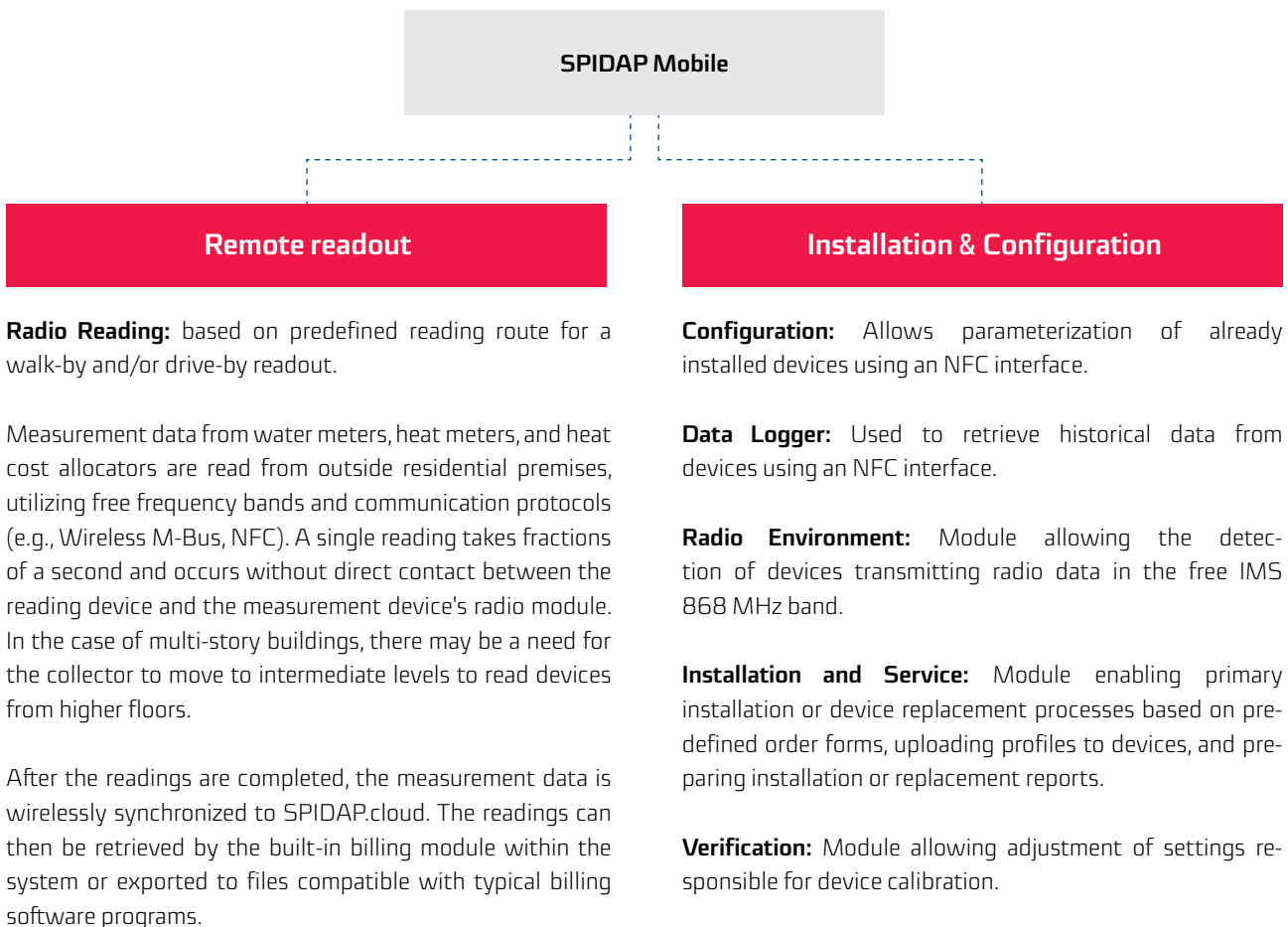

Key Benefits

Benefits for Water Supplier:

- Improved organization and higher efficiency of meter reading processes
- Reduction in water losses
- Access to readings via a web portal
- Alerts for anomalies in meter or installation operations
- Positive impact on company image as customer-friendly
- Rapid response to network failures through the installation of automatic valves at nodes

Benefits for Water Consumer:

- Information on current water consumption, promoting water conservation and increasing efficiency in its use
- Alerts for anomalies in meter or installation operations (via SMS or email)
- Access to historical data
- Meter reading without staff involvement, without the need for additional devices
- Mobile application support

Benefits of Intelligent Metering:

- Control and notification functions
- Users can set logical alarms, defining mathematical formulas comparing read values or results with a user-defined threshold over time. For example, a small increase in volume on the water meter over the next three hours may indicate a leak in the installation, and notification of such an increase in the water meter reading will be immediately sent to the consumer. Such alarms allow for quick identification of failures and precise identification of internal installation faults or areas requiring adjustment.

Main Advantages of the SPIDAP Cloud Platform

- Clear graphical interface and ease of use with value labels
- Ability to set logical alarms to detect improper installation operation and meter malfunctions
- Provision of access to readings to customers for water consumption control and efficiency improvement
- By installing a meter in a building, its purpose is known, which needs to be reflected in the system by selecting the appropriate label, e.g., main water meter
- Open architecture supporting various types of devices from different manufacturers
- Expandability
- Use of communication modules or 868MHz wireless MBus OMS signal converters
- Data exchange with external SCADA systems via dedicated APIs
- Intuitive operation

Reports and Meter Readings Export:

- The platform converts collected data into specified file structures in compatible formats and transfers them to other systems, such as billing systems, at specified intervals. Various report and export formats can be created, tailored to each client's requirements.

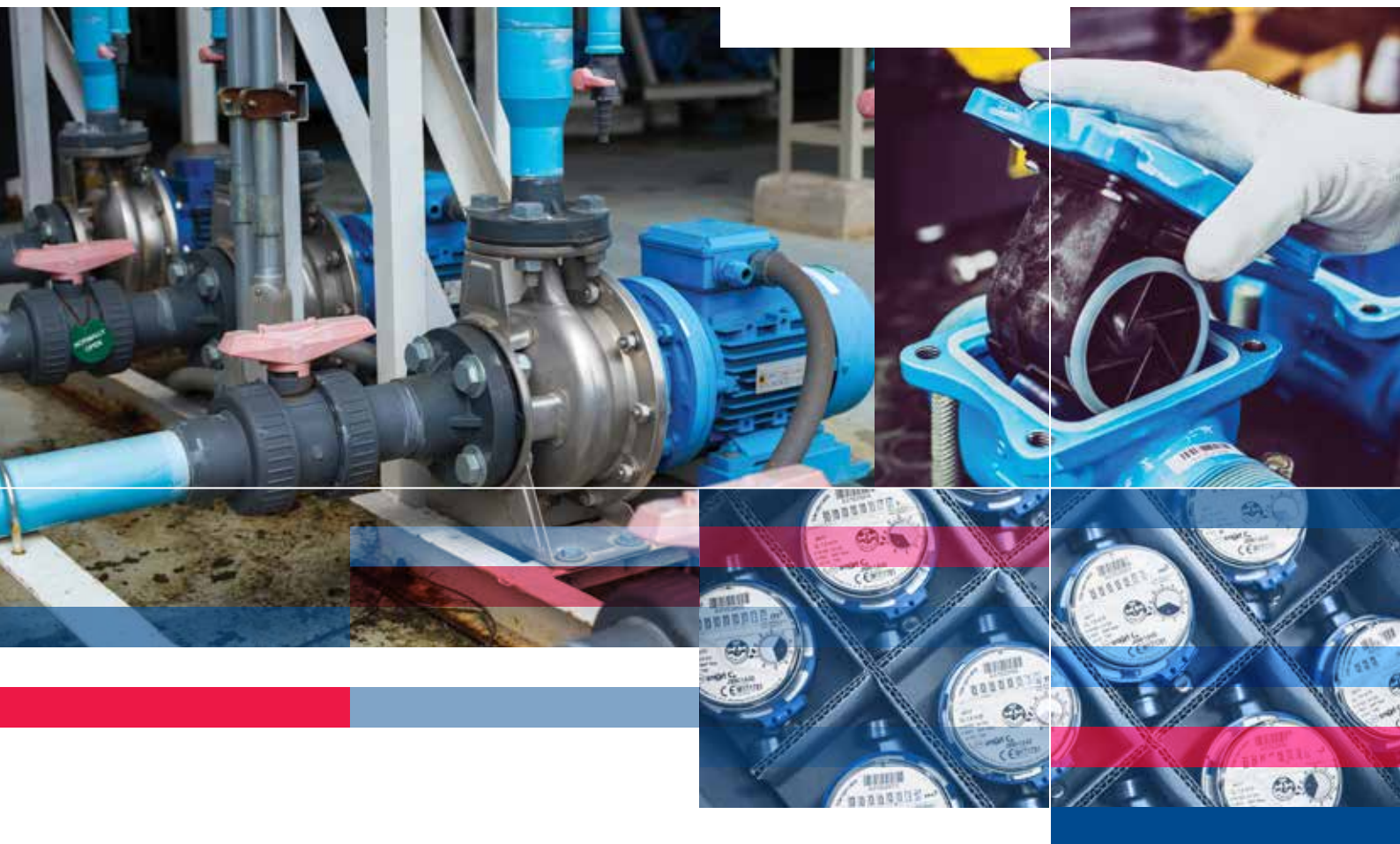

Complementary
range

WATER AND HEAT METER ACCESSORIES

Table 36. Water and heat meter half unions

Model*	Nut size (G)	End size (g)	Diameter (d)	Length (L)	Net weight (kg)
DN15 mm kit of half unions w/gaskets	¾"	½"	17 mm	37.5 mm	0.13
DN20 mm kit of half unions w/gaskets	1"	¾"	23 mm	45.6 mm	0.23
DN25 mm kit of half unions w/gaskets	1¼"	1"	29 mm	46.5 mm	0.42
DN32 mm kit of half unions w/gaskets	1½"	1¼"	36 mm	56.0 mm	0.7
DN40 mm kit of half unions w/gaskets	2"	1½"	43 mm	66.0 mm	1
DN50 mm kit of half unions w/gaskets	2½"	2"	54 mm	74.2 mm	1.2

* The kit of half unions includes: 2 unions + 2 nuts + 2 gaskets (EPDM rubber or FIBRA)

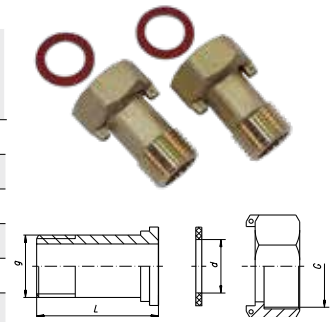

Table 37. Water and heat meter extension pieces

Model	G	L
DN20 extension piece	1"	20 mm; 30 mm; 40 mm; 60 mm

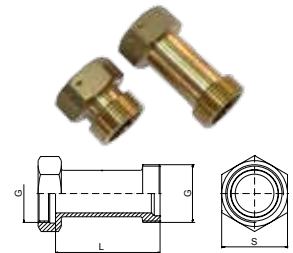

Table 38. Coupling check valve for unions or water and heat meters: fitting is guaranteed for Apator Powogaz fittings.

Model	Port size (g)
EA check valve, installed on the DN15 mm water meter outlet	½"



EA

Table 39. Coupling clamps w/snap-on tamper seals

Model	Blue
DN15 (½") clamp with tamper seal	X
DN20 (¾") clamp with tamper seal	X
DN25 (1") clamp with tamper seal	X
DN32 (1¼") clamp with tamper seal	X
DN40 (1½") clamp with tamper seal	X
DN50 (2") clamp with tamper seal	X



Table 40. Butterfly tamper seal with seal wires

Model	Seal wire length
Butterfly tamper seal	40 cm
Butterfly tamper seal	60 cm

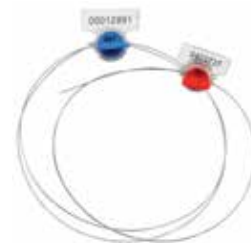

Table 41. Tee pipes for immersion temperature sensors

Model	Size	Length
DN15 / M10x1 tee	1/2"	55 mm
DN20 / M10x1 tee	3/4"	63.5 mm



Table 42. Reducer for immersion temperature sensors

Model	Size
DN15 / M10x1 reducer	1/2"



Table 43. Ball valves for immersion temperature sensors

Model	Size
Ball valve, DN15 / M10x1	1/2"
Ball valve, DN20 / M10x1	3/4"



Table 44. Ball valves

Model	Size
DN15 ball valve	1/2"
DN20 ball valve	3/4"
DN25 ball valve	1"



Table 45. Water meter reducers

Model	G1	G2	L
1" x 3/4" reducer	1"	3/4"	20

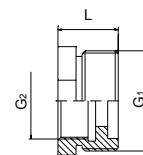

The data presented in the catalogue is valid on the date of issue.

The manufacturer has the right to modify and improve the products without prior notice.

This publication is intended for information purposes only and shall not be construed as a commercial offer under the Polish Civil Code.



Apator Powogaz S.A.

Jaryszki 1c, 62-023 Żerniki, Poland

Office: sekretariat.powogaz@apator.com, tel. +48 61 84 18 101

Sales / Customer Service: tel.: +48 61 84 18 149

Customer Service Centre Support: handel.powogaz@apator.com

Exports: export.powogaz@apator.com

Technical Support: support.powogaz@apator.com, tel. +48 61 8418 131, 134, 294

Warranty Claims: reklamacje.powogaz@apator.com